

ASSEMBLY INSTRUCTIONS

CrossHook System

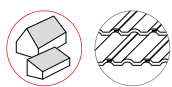

Content

▶ Tools overview	3
▶ General safety information	4
▶ Required Materials	6
▶ Assembly	9
▶ Notes	16

QUALITY TESTED – SEVERAL CERTIFICATIONS

K2 Systems stands for secure connections, highest quality and precision. Our customers and business partners have known that for a long time. Independent institutes have tested, confirmed and certified our capabilities and components.

Please find our quality and product certificates under:
www.k2-systems.com/en/technical-information



Tools overview

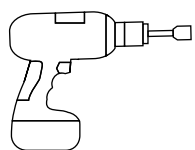

25 / 40



6-30Nm
(4,5-22,2 lb-ft)



6mm

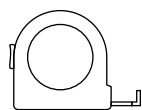

≥3,0m



≥6,0m

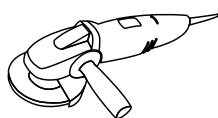

General safety information

Please note that our general mounting instructions must be followed at all times and can be viewed online at www.k2-systems.com/en/technical-information.

- ▶ The equipment may only be installed and operated by qualified and adequately trained installers.
- ▶ Prior to installation, ensure that the product complies with on-site static loading requirements. For roof-mounted systems, the roof load-bearing capacity must always be checked.
- ▶ National and local building regulations and environmental requirements must be adhered to.
- ▶ Compliance with health and safety regulations, accident prevention guidelines and applicable standards is required.
 - Protective equipment such as safety helmet, boots and gloves must be worn.
 - Roofing works must be in accordance with roofing regulations utilising fall protection safeguards when eaves height exceeds 3 m.
 - At least two people must be present for the duration of the installation work in order to provide rapid assistance in the event of an emergency.
- ▶ K2 mounting systems are continuously developed and improved and the installation process may thereby change at any time. Prior to installation consult our website at www.k2-systems.com/en/technical-information for up-to-date instructions. We can send you the latest version on request.
- ▶ The assembly instructions of the module manufacturer must be adhered to.
- ▶ Equipotential bonding/grounding/earthing between individual parts is to be performed according to country specific standards, as well as national laws and regulations.
- ▶ At least one copy of the assembly instructions should be available on site throughout the duration of the installation.
- ▶ Failure to adhere to our general safety and assembly instructions and not using all system components, K2 is not liable for any resulting defects or damages. We do not accept liability for any damage resulting in the use of competitor's parts. Warranty is excluded in such cases.
- ▶ German law shall apply excluding the UN Convention on CISG. Place of venue is Stuttgart. Our General Terms of Business apply.
- ▶ If all safety instructions are adhered to and the system is correctly installed, there is a product warranty entitlement of 12 years! We strongly recommend reviewing our terms of guarantee, which can be viewed at www.k2-systems.com/en/technical-information
We will also send this information on request.
- ▶ Dismantling of the system is performed in reverse order to the assembly.
- ▶ K2 stainless steel components are available in different corrosion resistance classes. Each structure or component must be carefully checked for possible corrosion exposure.

The following guidelines apply



The CrossHook system can be used without further testing by K2 systems in the following standard conditions. To calculate maximum distances between supports we recommend using our calculation tool K2Base. The system is also suitable for higher requirements. However, if a value exceeds the standard conditions, please contact K2 Systems.



ROOF REQUIREMENTS

- ▶ The sufficient holding force of the roof covering at the support or substructure must be ensured on site.
- ▶ Roof pitch of 5 – 75°



IMPORTANT MOUNTING INSTRUCTIONS

- ▶ On-site general standards and regulations for lightning protection must be observed and consultation with a specialist to create a lightning protection concept is recommended (use lightning protection clamp if necessary).
- ▶ We recommend a thermal separation after maximum of 18.3 m.
- ▶ Do not use Middle and End Clamp set at rail joints.
- ▶ Minimum spacing of 50 mm from module edge to rail end.
- ▶ Tightening torque for all module clamps 14 Nm
- ▶ For manufacturer information regarding clamps see the manufacturing module data sheet.
- ▶ To avoid tiles breaking under high snow loads, arrange for supporting the bracket with a suitable metal support plate.
- ▶ Do not step on roof hooks or rails, aren't climbing assists.
- ▶ Sizing and positioning of the wood screws are subject to the relevant regulations.
- ▶ Dimensioning and positioning of the woodscrews subject to the European Technical approvals (ETA) of the screw manufacturers.
- ▶ Special requirements apply with on-rafter insulation or counter battening: special fit-for-purpose spacer screws have to be used.

Essential: The materials required

All system components listed in the following are essential for assembling the K2 Systems CrossHook system. The piece quantities are calculated on the basis of the respective requirements. The listed item numbers facilitate the comparison of items.



K2 CrossHook 3S Set | 2001672

height under bracket: 40/47/54 mm
Material: aluminium

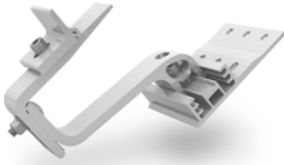

K2 CrossHook 4S Set | 2001821

height under bracket: 40/47/54 mm position bracket height adjusting range 30 mm
Material: aluminium



K2 Self-drilling wood screw round head | Article number system-specific

Material: stainless steel A2, bit TX 25 for M6, TX 40 for M8

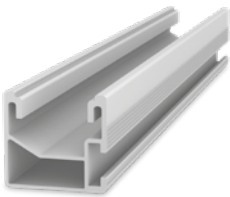

Mounting Rail K2 SingleRail | Article number system-specific

Material: aluminium EN AW-6063 T66

Alternatively: Mounting Rail K2 CrossRail | Article number system-specific
Material: aluminium EN AW-6063 T66



K2 SingleRail 36 Rail connector Set | Article number system-specific

Material: aluminium EN AW-6063 T66, stainless steel A2

Alternatively: K2 CrossRail 36 Rail connector Set | Article number system-specific
Material: aluminium EN AW-6063 T66, stainless steel A2



Optional: K2 Pad Spacer | 1002361

Material: glass fibre reinforced PA



K2 EndCap CrossRail/ SingleRail 36 | 1004767

Material: glass fibre reinforced PA

Alternativ: K2 EndCap CrossRail 48 | 1004768
Material: glass fibre reinforced PA



K2 Universal module middle clamps OneMid

| 2002515

Module frame height: 32 - 42 mm

Alternatively: K2 Module Middle Clamp XS Set

| Article number system-specific

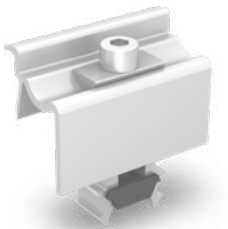

K2 Universal module end clamps OneEnd

| 2002514

Module frame height: 32 - 42 mm

Alternatively: K2 Module End Clamp Standard Set

| Article number system-specific

ADDITIONAL MATERIAL FOR CROSS BRACING

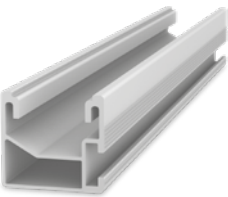

Mounting Rail K2 SingleRail

Material: aluminium EN AW-6063 T66

| Article number system-specific

Alternatively: Mounting Rail K2 CrossRail

Material: aluminium EN AW-6063 T66

| Article number system-specific



K2 Climber 36/48 Set

| 1006041

The set consists of:

- ▶ 1 Climber 36/48, aluminium EN AW-6063 T66
- ▶ 1 Bolt with serrated under head M8x25, stainless steel A2
- ▶ 1 M K2 slot nut with clip, stainless steel und PA

Assembly

1 UNCOVER RAFTERS (REMOVE TILES)

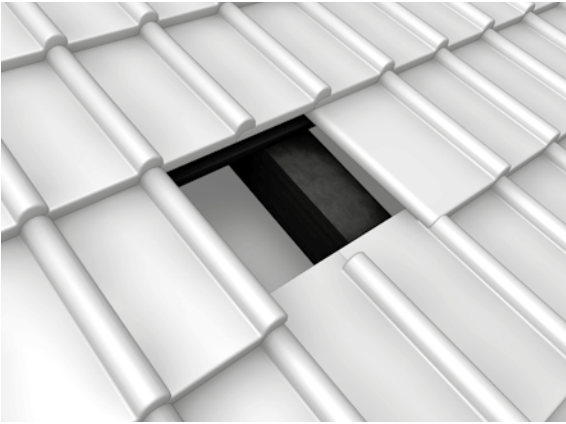

The rafters, on which the roof fasteners are to be mounted, must be exposed. The height of the roof fastener must be checked and adjusted if necessary.

2 ASSEMBLE ROOF FASTENER



The roof fastener must be mounted with a minimum of two stainless steel timber screws on the wooden rafters (at least one screw per row of holes). Choosing the dimensions and position of the screws has to be carried out according to the applicable regulations. This also applies to on-roof insulation or counter lathing. Horizontally align the roof hook hangers in order to get into the hollow of the tile. Untighten the Allen bolt in the bracket. After adjusting the bracket fasten the Allen bolt. Torque moment 16 Nm. If the bracket will sit right at the edge of the baseplate make sure the bracket is at least flush with the baseplate edge.

Flex deck tiles and lower tiles in the area of the hanger. The top edges of a horizontal row must be at the same height.

The roof fasteners must be mounted in such a way that there is a minimum spacing of 5 mm between the roof fastener bracket and the tile.

When using the Crosshooks 4S, an additional height adjustment of the bracket itself is possible. The bolt is tightened to 14 Nm.

(The amount of roof fasteners that need to be mounted depends on roof requirements and will be specified when order is placed.)

Required materials: K2 CrossHook 3S / 4S, K2 Self-drilling wood screw round head

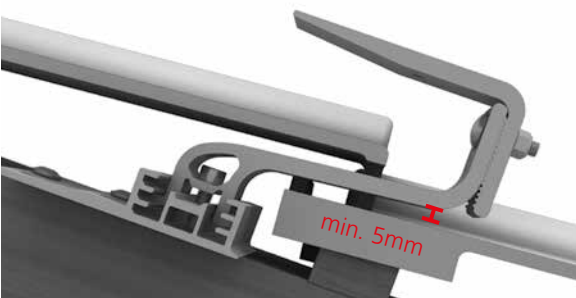
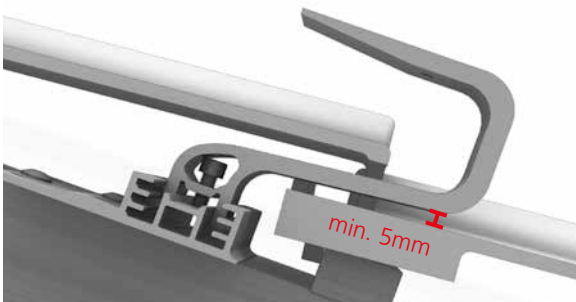

3 MOUNTING RAIL ASSEMBLY



The Mounting Rail is mounted on to the roof fastener using K2 Climbers and K2 Bolts with serrated under head. Tightening torque 16 Nm.

Due to thermal expansion, the rows must be max. 18.3 m. The minimum spacing for separation between the two K2 rails is 3 - 5 cm.

Smaller unevenness is offset by one or more stacked K2 Pads.

4 RAIL CONNECTOR ASSEMBLY



Lay Mounting Rail on joint with rail connector and connect with T bolts and self-locking nuts. The rail joint may not be in the range of the roof fastener.

Tightening torque 16 Nm.

5 ATTACH MODULE GAPS



Fix the module in place at the end of a row with universal module end clamp OneEnd. Click the Stance in the notches. Alternatively use the standard end clamp. Insert the MK2 nut into the mounting rail and turn clockwise by 90 °. Place clamps on the module frames and fix them. Never mount module end clamps directly on the rail joint or end of the rail! (Spacing: min. 50 mm from edge of module frame). Pay attention to the mounting instructions by module manufacturer!

Tightening torque 14 Nm.



Use two universal module middle clamp OneMid between two modules. Click the Stance in the notches. Place clamps on the module frames and fix them. Tightening torque 14 Nm.



Alternatively: Use two XS middle clamps between two modules

ALTERNATIVE SYSTEM DESIGNS (CROSS BRACING) WITH SINGLERAIL

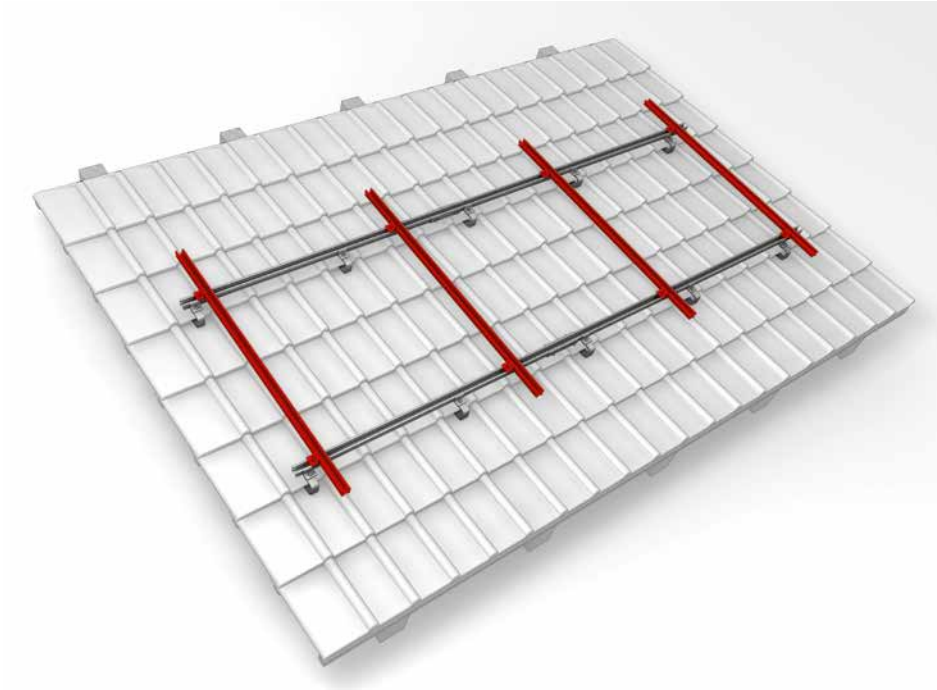

In cross bracing, the upper rail position is fitted using the

M K2 slot nut, climber and bolt with serrated under head M8 to the desired location, with appropriate spacing.

Tightening torque 16 Nm.

Notes

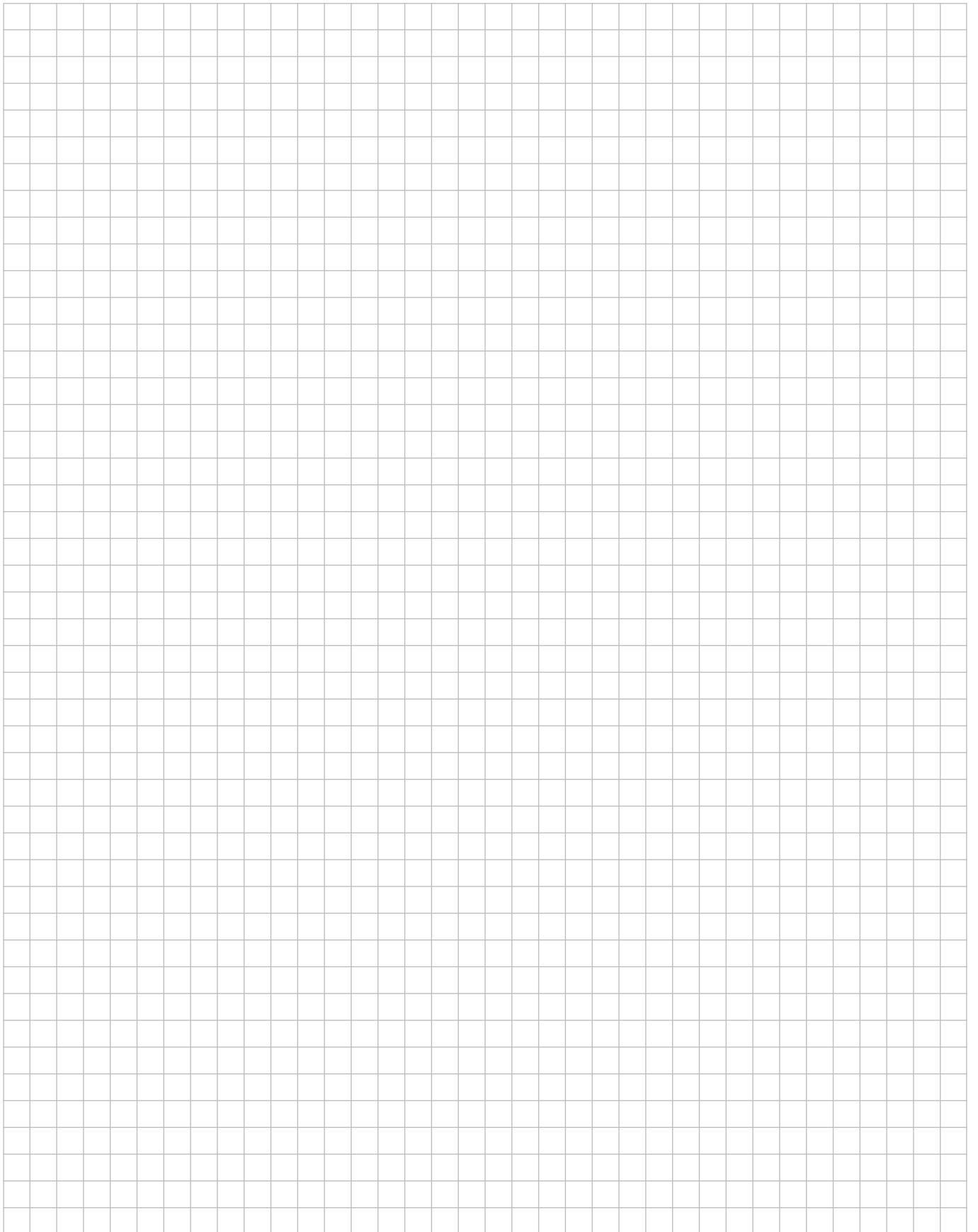

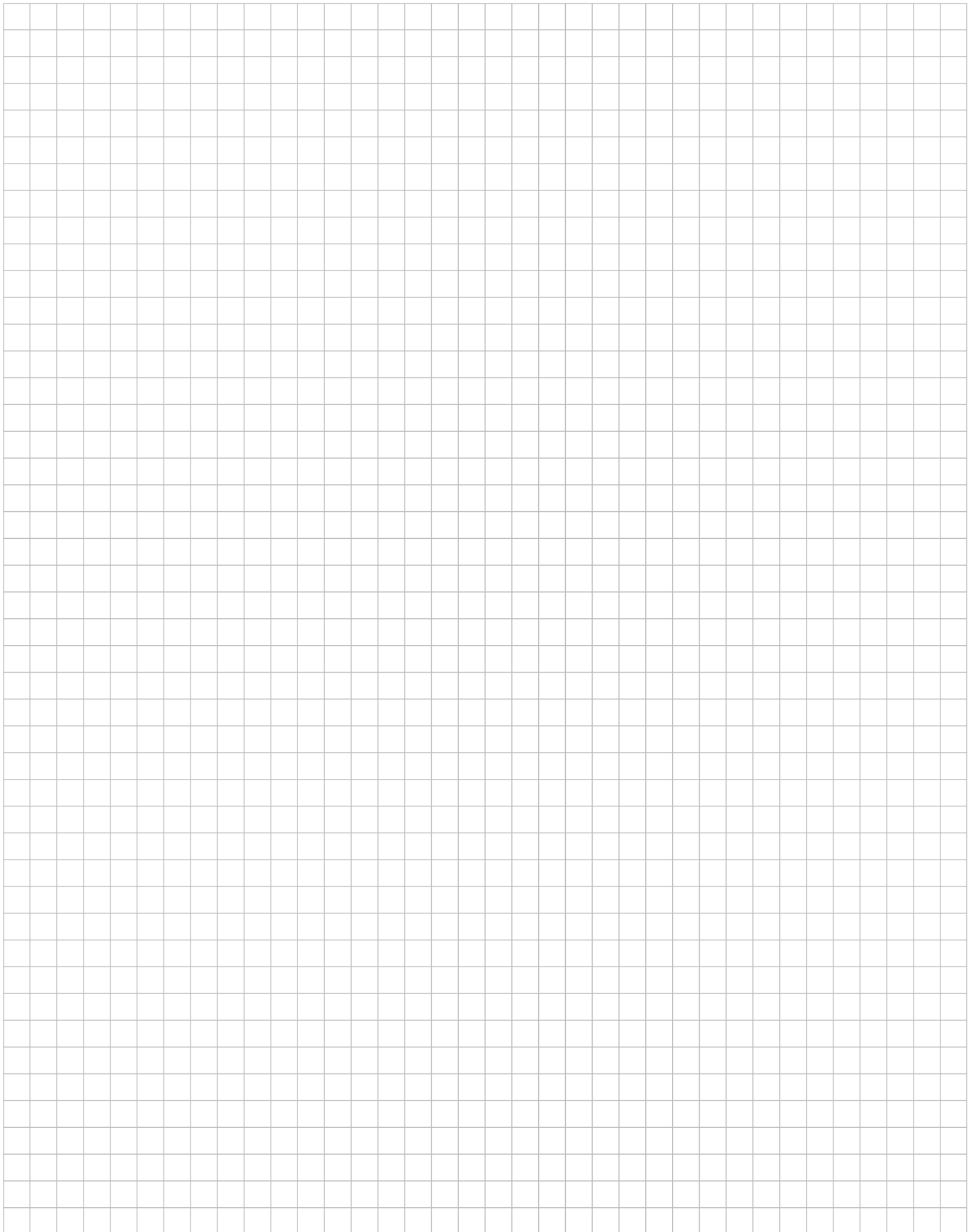

THANK YOU FOR CHOOSING A K2 MOUNTING SYSTEM.

Systems from K2 Systems are quick and easy to install. We hope these instructions have helped. Please contact us with any questions or suggestions for improvement.

Our contact data:

- ▶ www.k2-systems.com/en/contact
- ▶ **Service Hotline: +49 (0)7159 42059-0**

German law shall apply excluding the UN Convention on CISG.
Place of venue is Stuttgart.

Our General Terms of Business apply. Please refer:
www.k2-systems.com

K2 Systems GmbH

Industriestraße 18
71272 Renningen
Germany

Tel. +49 (0) 7159 - 42059 - 0
Fax +49 (0) 7159 - 42059 - 177

info@k2-systems.com
www.k2-systems.com