

ECOFLOW

AURINKOPANEELI

×

Käyttöopas

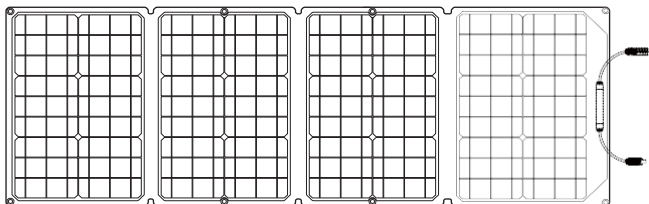

110 W:n aurinkopaneeli
yksikiteisillä piikkennoilla

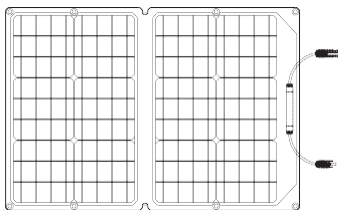

60 W:n aurinkopaneeli
yksikiteisillä piikkennoilla

Ota yhteyttä:

support@ecoflow.com

www.ecoflow.com

Pakkauksen si-



Suojakotelo ja jalusta vain 110 W aurinkopaneelille



110/60 W Aurinkopaneeli



Käyttöopas ja takuukortti

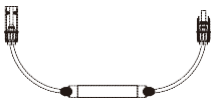

MC4-säädin

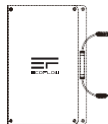

Säädin

LISÄVARUSTE



MC4-XT60-kaapeli latausta varten
EF DELTA/R600

* Tämä kaapeli myydään erikseen

Miten se toimii?

R600:n lataaminen

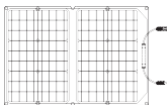

MC4-lähtöliittimet

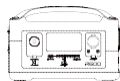

R600
(myydään erikseen)

6,5–13 tuntia (60 W) (riippuen säästä)

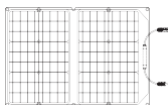

110/60 W:N AURINKOPANEELI



MC4-TX60

* Tämä kaapeli myydään erikseen



XT60-SYÖTTÖLIITIN

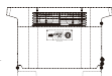

EF DELTA
(myydään erikseen)



R600
(myydään erikseen)

Laitteen lataaminen

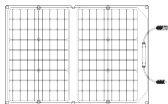

MC4-lähtöliittimet



R600
(myydään erikseen)



EF DELTA
(myydään erikseen)

Pystyttäminen

Pystytuen käyttäminen

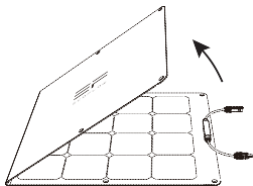

1

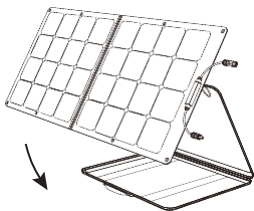

2

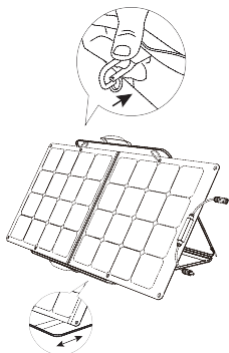

3

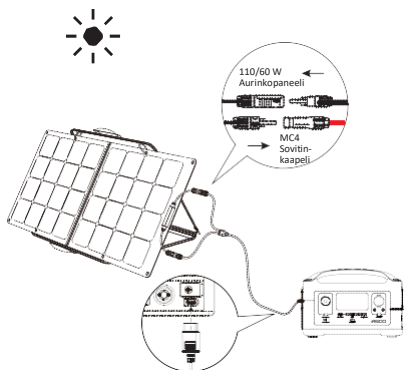

4

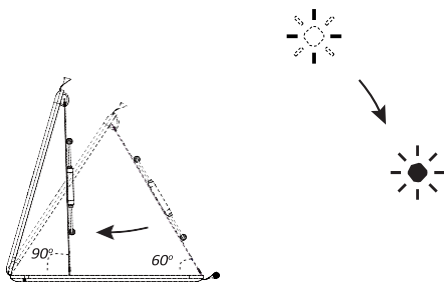

5

*Käytä suojakoteloä jalustana, jotta saat aurinkopaneelin 60–90 asteen kulmaan parhaan tehokkuuden saavuttamiseksi.

Miten se toimii?

Kaksi tapaa saada lisää tehoa!

1. Kytke kaksi 110 W:n tai 60 W:n aurinkopaneelia R600:n kahteen liitäntään (sarjaliitintää ei tueta).

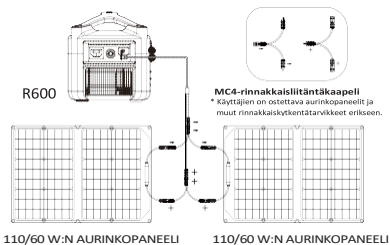

2. Kytke kolme 110 W:n tai 60 W:n aurinkopaneelia EFDELTAan.

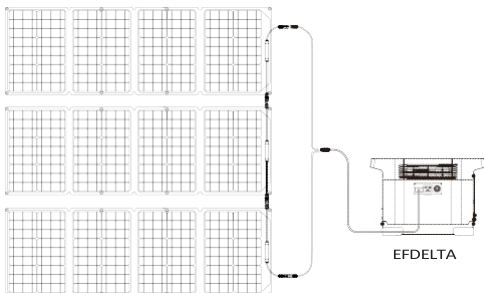

* Jokainen 110/60 W:n aurinkolaturi myydään erikseen.

1. Mitä 110/60 W:n aurinkopaneeli voi ladata?

Jokaisessa 110/60 W:n aurinkopaneelissa on MC4-XT60-kaapeli, jota käytetään R600/EF DELTAn lataamiseen.

2. Antaako 110/60 W:n aurinkopaneeli täyden 110/60 watin tehon? Optimaalisissa olosuhteissa 110/60 W:n aurinkolaturi voi tuottaa jopa 110/60 watin tehon, mutta paneelin kulma ja sää voivat vaikuttaa sen suorituskykyyn.

3. Onko 110/60 W:n aurinkopaneeli vedenkestävä?

110/60 W:n aurinkopaneeli on valmistettu vedenkestävästä materiaalista, joten se on kestävä ja helppo käyttää ulkona.

4. Voinko ketjuttaa useita 110/60 W:n aurinkopaneeleita yhteen?

Ketjutusominaisuuden ansiosta voit ketjuttaa enintään kolme 110/60 W:n aurinkopaneelia yhteen MC4-kaapelilla. Huomaa, että R600 ei tue sarjaliitosta. Suojaominaisuudet estävät paneeleita lataamasta R600:aa, jos ketjutat vahingossa liian monta laitetta yhteen.

5. Kuinka kauan kestää ladata R600 aurinkopaneelin avulla?

R600 voidaan ladata 110 W:n aurinkopaneelilla 5–10 tunnissa ja 60 W:n aurinkopaneelilla 6,5–13 tunnissa paneelien kulmasta ja sääolosuhteista riippuen.

Tekniset tiedot

110 W:n aurinkopaneeli
Nimellisteho: 110 W (+/- 5 W)*
Avoimen piirin jännite: 21,7 V (Vmp 18,5 V)
Oikosulkuvirta: 6,3 A (Imp 6,0 A)
Hyötysuhde: 21–22 %
Kennotyyppi: Yksikiteinen pii
Yleistä
Paino: 6 kg Aurinkopaneeli: 4 kg
Mitat avattuna: 51,4 x 158 x 2,0 cm
Mitat taitettuna: 51,4 x 42 x 2,0 cm
Takuu: 1 vuosi
Lähtöportit
MC4-lähtö XT60:een: 100 V, jopa 12 A
Testattu ja sertifioitu
    

60 W:n aurinkopaneeli
Nimellisteho: 60 W (+/- 5 W)*
Avoimen piirin jännite: 21,6 V (Vmp 18,2 V)
Oikosulkuvirta: 3,5 A (Imp 3,3 A)
Hyötysuhde: 21–22 %
Kennotyyppi: Yksikiteinen pii
Yleistä
Paino: 4 kg Aurinkopaneeli: 2,0 kg
Mitat avattuna: 53,7 x 81,5 x 2 cm
Mitat taitettuna: 53,7 x 42 x 2 cm
Takuu: 1 vuosi
Lähtöportit
MC4-lähtö XT60:een: 100 V, jopa 12 A
Testattu ja sertifioitu
    

*Vakiotestiolosuhteet: 1000 W/m², AM1,5, 25 °C

ECOFLOW SOLCELLSPANEL

×

Bruksanvisning

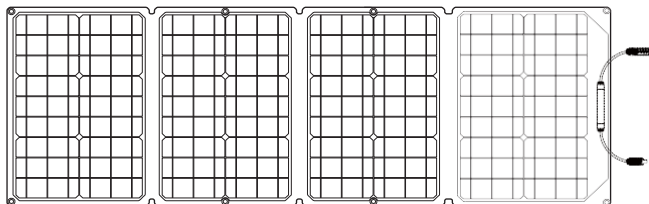

110 W solpanel
med monokristallina kiselceller

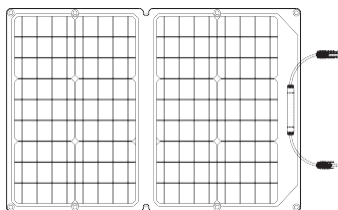

60 W solpanel
med monokristallina kiselceller

Kontakta oss:
support@ecoflow.com
www.ecoflow.com

Förpackning-



Skydd och stativ endast för 110 W solcellspanel



110/60 W Solcellspanel



Bruksanvisning och garantkort

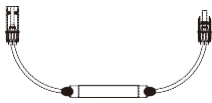

MC4-regulator

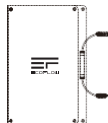

Regulator

TILLBEHÖR



MC4-XT60-kabel för laddning EF DELTA/R600

* Den här kabeln säljs separat

Hur fungerar det?

Laddning av R600

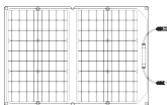

MC4-utgångskontakter



6,5-13 timmar (60 W) (beroende på väder)

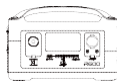

R600 (säljs separat)

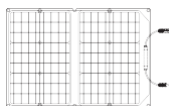

110/60 W SOLCELLSPANEL



MC4-TX60
* Den här kabeln säljs separat



XT60-IN-
GÄNGSKON-
TAKT

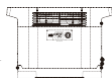

EF DELTA
(säljs separat)



R600
(säljs separat)

Ladda enheten

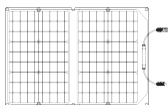

MC4-utgångskontakter



R600
(säljs separat)



EFDELTA
(säljs separat)



Att sätta upp

Använda stativet

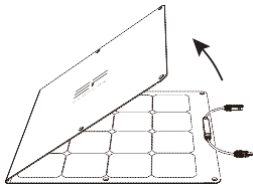

1

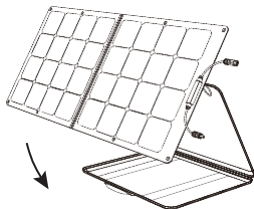

2

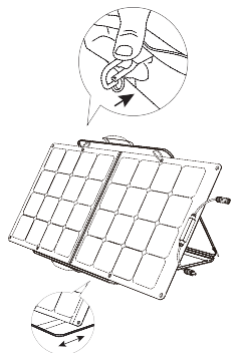

3

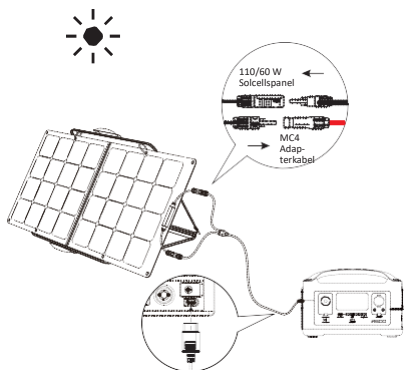

4

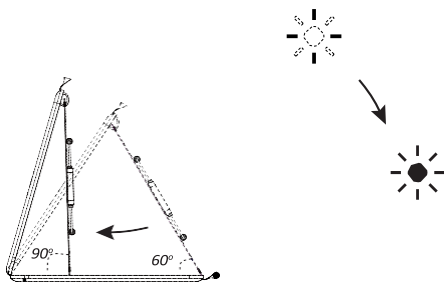

5

*Använd skyddet som ett stativ för att placera solpanelen i en vinkel på 60-90 grader för bästa effektivitet.

Hur fungerar det?

Två sätt att få mer kraft!

3. Anslut två solpaneler på 110 W eller 60 W till de två uttagen på R600 (seriell anslutning stöds inte).

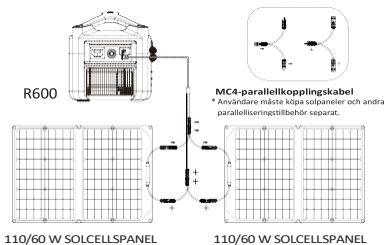

4. Anslut tre 110 W eller 60 W solpaneler till EFDELTA.

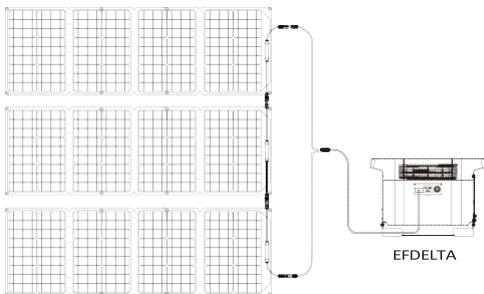

* Varje 110/60 W solcellsladdare säljs separat.

Vanligt ställda frågor

1. Vad kan en 110/60 W solpanel ladda?

Varje 110/60 W solpanel är utrustad med en MC4-XT60-kabel som används för att ladda R600/EF DELTA.

2. Kommer en 110/60 W solpanel att ge full 110/60 W effekt? Under optimala förhållanden kan en 110/60 W solcellsaddare producera upp till 110/60 W, men panelens vinkel och vädret kan påverka dess prestanda.

3. Är en 110/60 W solpanel vattentät?

Solpanelen på 110/60 W är tillverkad av vattenbeständigt material, vilket gör den hållbar och lätt att använda utomhus.

4. Kan jag koppla ihop flera 110/60 W solpaneler?

Med hjälp av kedjefunktionen kan du kedja upp till tre 110/60 W solpaneler tillsammans med en MC4-kabel. Observera att R600 inte stöder seriell anslutning. Skyddsfunktioner förhindrar att paneler laddar R600 om du råkar kedja ihop för många enheter.

5. Hur lång tid tar det att ladda R600 med en solpanel?

R600 kan laddas på 5-10 timmar med en 110 W solpanel och på 6,5-13 timmar med en 60 W solpanel, beroende på panelernas vinkel och väderförhållandena.

Teknisk information

110 W solpanel
Nominell effekt: 110 W (+/- 5 W)*
Spänning i öppen krets: 21,7 V (Vmp 18,5 V)
Kortslutningsström: 6,3 A (Imp 6,0 A)
Effektivitet: 21–22 %
Solcellstyp: Monokristallint kisel
Allmänt
Vikt: 6 kg Solcellspanel: 4 kg
Mått som öppnad: 51,4 x 158 x 2,0 cm
Mått som hopvik: 51,4 x 42 x 2,0 cm
Garanti: 1 år
Utanslutningar
MC4-utgång till XT60: 100 V, upp till 12 A
Testad och certifierad
    

60 W solpanel
Nominell effekt: 60 W (+/- 5 W)*
Spänning i öppen krets: 21,6 V (Vmp 18,2 V)
Kortslutningsström: 3,5 A (Imp 3,3 A)
Effektivitet: 21–22 %
Solcellstyp: Monokristallint kisel
Allmänt
Vikt: 4 kg Solcellspanel: 2,0 kg
Mått som öppnad: 53,7 x 81,5 x 2 cm
Mått som hopvik: 53,7 x 42 x 2 cm
Garanti: 1 år
Utanslutningar
MC4-utgång till XT60: 100 V, upp till 12 A
Testad och certifierad
    

*Standardtestförhållanden: 1000 W/m², AM1,5, 25 °C

ECOFLOW SOLAR PANEL

×

User Manual

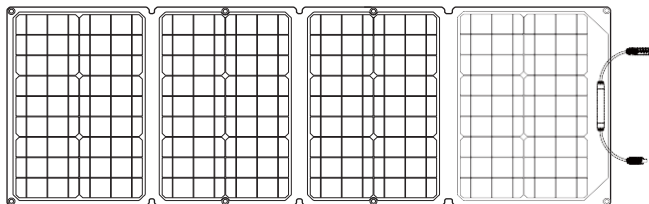

110W Solar Panel
with Monocrystalline silicon
cells

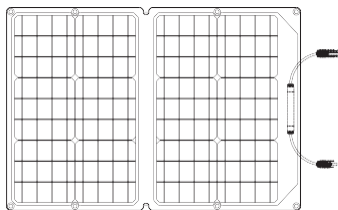

60W Solar Panel
with Monocrystalline silicon
cells

Contact Us: [sup-
port@ecoflow.com](mailto:support@ecoflow.com)
www.ecoflow.com

In The Box



Protective Case and kickstand
only for 110W Solar Panel



110W/60W
Solar Panel



User Manual
& Warranty Card

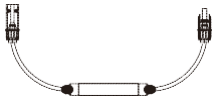

MC4 Output Controller

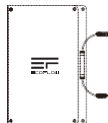

Output
Controller

OPTIONAL



MC4 to XT60 Cable
for Recharging
EF DELTA/R600

* This Cable sold separately

How it Works

How to Recharge R600

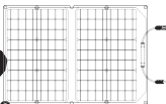

MC4 Output Ports

6.5-13Hours(60w) (Depends
on Weather)

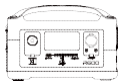

R600
(Sold Separately)

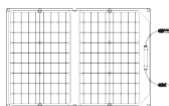

110W/60W SOLAR PANEL



MC4 to TX60
* This Cable sold separately



XT60 IN-
PUT PORT

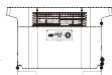

EF DELTA
(Sold Separately)



R600
(Sold Separately)

How to Recharge Your Devices

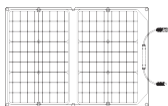

MC4 Output Ports



R600
(Sold Separately)



EFDELTA
(Sold Separately)



Your Solar Setup

Using Your Kickstand

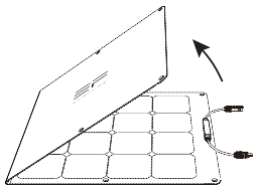

1

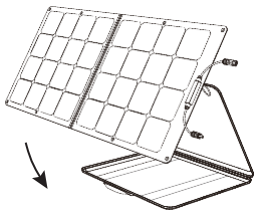

2

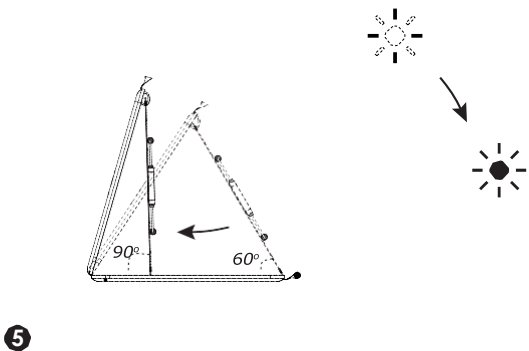
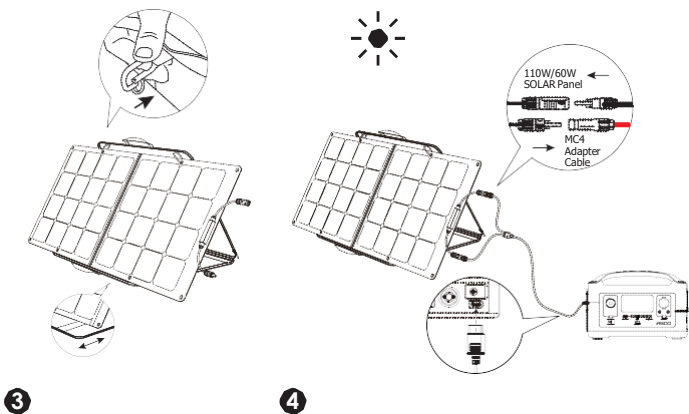

*Use the solar panel bag as a kickstand to prop your solar panel in a 60-90 degree angle for best efficiency.

How It Works

Two Ways to Get More Power!

5. Connect two 110W or 60W solar panels to the two Ports on R600 (Series connection not supported)

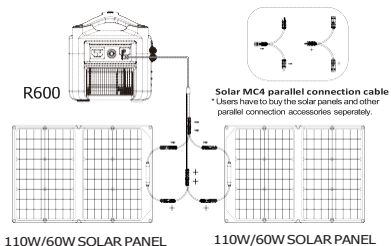

6. Chain three 110W or 60W solar panels to EFDELTA.

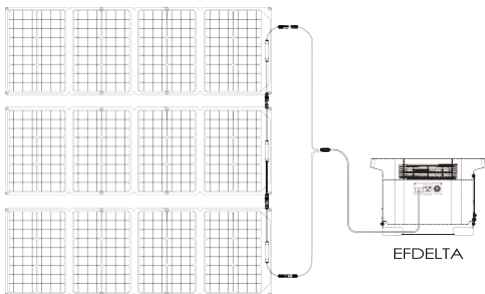

* Each 110W/60W Solar charger sold separately

FAQs

1. What can the 110W/60W Solar Panel charge?

Each 110W/60W Solar Panel has a mc4 to XT60 cable which is used to recharge R600/EF DELTA

2. Does the 110W/60W Solar Panel give a full 110/60W watts of power?

Under optimal conditions the 110W/60W Solar Charger can deliver up to 110/60Watts of power, but the angle of the panels and the weather can impact its performance.

3. Is the 110W/60W Solar Panel water resistant?

The 110W/60W Solar Panel is made of water resistant material, making it durable and easy to use in the outdoors.

4. Can I chain multiple 110W/60W Solar Panel together?

The chainable feature enables you to chain a maximum of three 110W/60W solar panels together with the MC4 cable. Please note that R600 cannot support series connection. Our safety system will prevent the panels from charging R600 should you accidentally chain too many devices together.

5. How long does it take to recharge R600 with the solar panel?

R600 can be recharged via the 110W solar panel in 5-10 hours and the 60W solar panel in 6.5-13 hours, depending on the angle of the panels and weather conditions.

Technical Specifications

110w Solar Panel
Rated Power: 110W(+/-5W)*
Open Circuit Voltage: 21.7V(Vmp 18.5V)
Short Circuit Current: 6.3A(Imp 6.0A)
Efficiency: 21%-22%
Cell Type: Monocrystalline silicon
General
Weight: 13.2 lbs (6KG) Solar Panel 8.8lbs (4KG)
Unfolded Dimensions: 20.2*62.5*0.8 in (51.4*158*2.0 cm)
Folded Dimensions: 20.2*16.5*0.8 in (51.4*42*2.0 cm)
Warranty: 12 months
Output Ports
MC4 Solar Port to XT60: 100V(max), up to 12A (max)
Tested And Certified

60w Solar Panel
Rated Power: 60W(+/-5W)*
Open Circuit Voltage: 21.6V(Vmp 18.2V)
Short Circuit Current: 3.5A(Imp 3.3A)
Efficiency: 21-22%
Cell Type: Monocrystalline silicon
General
Weight: 8.8 lbs(4KG) Solar Panel 4.4 lbs(2.0KG)
Unfolded Dimensions: 21*32.1*0.8in(53.7*81.5*2cm)
Folded Dimensions: 21*16.5*0.8 in(53.7*42*2cm)
Warranty: 12 months
Output Ports
MC4 Solar Port to XT60: 100V(max), up to 12A (max)
Tested And Certified

*Standard Test Conditions: 1000W/m², AM1.5, 25°C