



Pure sine wave inverter

USER MANUAL



IPT350, IPT500

IPT1000, IPT1500

IPT2000, IPT3000

IPT4000, IPT5000

Contents

Important Safety Instructions	1
1 Overview	5
2 Appearance	6
3 Naming rule	11
4 Connection diagram	13
5 Installation	14
5.1 Attentions	14
5.2 Wire size and circuit breaker	14
5.3 Mounting	17
6 Parameters setting	23
6.1 Power Saving Mode	23
6.2 Other parameters	24
7 Protections	27
8 Troubleshooting	30
9 Maintenance	31
10 Specifications	32
Appendix 1 Disclaimers	44

Important Safety Instructions





Please reserve this manual for future review.

This manual contains instructions on the safety, installation, and operation of the IPT series high-frequency pure sine wave inverter ("inverter" as referred to in this manual).

1. Explanation of symbols

Please read related literature accompanying the following symbols to enable users to use the product efficiently and ensure personal and property safety.

Please read the literature accompanying the following symbols.

Symbols	Definition
TIP	Indicates any practical advice for reference
	IMPORTANT: Indicates a critical tip during the operation, if ignored, may cause the device to run in error.
	CAUTION: Indicates potential hazards. If not avoided, it may cause the device to be damaged.
	WARNING: Indicates the danger of electric shock. If not avoided, it would cause casualties.
	WARNING HOT SURFACE: Indicates the risk of high temperature, if not avoided, would cause scalds.
	Read the user manual carefully before any operation.

 WARNING	The entire system should be installed by professional and technical personnel.
---	--

2. Requirements for professional and technical personnel



- Professionally trained;
- Familiar with related safety specifications for the electrical system;
- Read this manual carefully and master related safety cautions.

3. Professional and technical personnel is allowed to do

- Install the inverter to a specified location.

- Conduct trial operations for the inverter.
- Operate and maintain the inverter.

4. Safety cautions before installation

 IMPORTANT	<p>When you receive the inverter, check whether there is any damage in transportation. Contact the transportation company, our local distributor, or our company for any problem.</p>
 CAUTION	<ul style="list-style-type: none"> • When placing or moving the inverter, follow the instructions in the manual. • When installing the inverter, evaluate whether the operation area exists arc danger. • The inverter needs to be connected to a battery. The battery's minimum capacity (Ah) is recommended to be five times the current that equals the inverter's rated output power divided by the battery's voltage.
 WARNING	<ul style="list-style-type: none"> • Keep the inverter out of the reach of children. • This inverter is an off-grid type. It is strictly prohibited to connect the inverter to the grid. Otherwise, the inverter will be damaged. • This inverter is only allowed for stand-alone operation. It is prohibited to connect multiple units in parallel or series. Otherwise, the inverter will be damaged.

5. Safety cautions for mechanical installation



 WARNING	<ul style="list-style-type: none"> • Before installation, ensure the inverter has no electrical connection. • Confirm enough heat dissipation space for the inverter before installation. Do not install the inverter in a harsh environment such as humid, salt spray, corrosion, greasy, flammable, explosive, or dust accumulation.
---	--

6. Safety cautions for electrical connection

 CAUTION	<ul style="list-style-type: none"> • Check whether wiring connections are tight to avoid the danger of heat accumulation due to loose connections. • The protective grounding is connected to the ground. The cross-section of the wire should not be less than 4mm². • The DC input voltage must strictly follow the parameter table. Too high or too low DC input voltage will affect the inverter's normal operation and damage it.
---	--

	<ul style="list-style-type: none"> • It is recommended that the connection length between the battery and the inverter be less than 3 meters. If greater than 3 meters, please reduce the current density of the connection wire. • A fast-acting fuse or breaker should be used between battery and Inverter; the fast-acting fuse or breaker's rated current should be twice the inverter rated input current. • DO NOT install the inverter close to the flooded lead-acid battery because the terminals' sparkle may ignite the hydrogen released by the battery.
 WARNING	<ul style="list-style-type: none"> • The AC output terminal is only for the load connection. Do NOT connect it to another power source or utility. Otherwise, the inverter will be damaged. Turn off the inverter when connecting loads. • It is strictly forbidden to connect a transformer or a load with a surge power (VA) exceeding the overload power at the AC output port. Otherwise, the damage will be caused to the inverter. • Do not connect battery chargers or other similar products to the input terminal of the inverter. Otherwise, the inverter will be damaged.

7. Safety cautions for controller operation

 WARNING HOT SURFACE	When the inverter is working, the cover temperature is very high because of the accumulated heat; please do not touch it.
 CAUTION	When the inverter is running, please do not open the cabinet.
 WARNING	The inverter's AC output is of high voltage, do not touch the wiring connection to avoid electric shock.

8. Dangerous operations which would cause an electric arc, fire, or explosion

- Touch the wire end that hasn't been insulation treated and may be electriferous.
- Touch the wiring copper row, terminals, or internal inverter modules that may be electriferous.
- The connection of the power cable is loose.
- Screw or other spare parts inadvertently falls into the inverter.
- Improper operations by untrained non-professional or technical personnel.



WARNING

Once an accident occurs, it must be handled by professional and technical personnel. Improper operations would cause more serious accidents.

9. Safety cautions for stopping the inverter

- The internal conductive modules could be touched after the inverter stopped running for five minutes.
- The inverter is allowed to restart after removing the faults, which affects the safety performance.
- There are no serviceable parts inside. If any maintenance service is required, please contact our local distributor or the service personnel.



WARNING

Do NOT touch or open the shell after the inverter is powered off within ten minutes.

10. Safety cautions for inverter maintenance

- It is recommended to check the inverter with testing equipment to ensure no voltage and current.
- When conducting electrical connection and maintenance, post a temporary warning sign or put up barriers to prevent the unrelated personnel from entering the electrical connection or maintenance area.
- An improper operation of the inverter may cause personal injury or equipment damage.
- It is recommended to wear an antistatic wrist strap or avoid unnecessary contact with the circuit board.



1 Overview





The IPT series, a high-frequency sine wave inverter, adopts a fully digital intelligent design and voltage-current dual closed-loop control algorithm. Featured with fast response, high conversion efficiency, low Total Harmonic Distortion(THD), and high reliability running, the IPT series can be widely used in the DC-AC off-grid systems (such as vehicle systems, security monitoring systems, emergency lighting systems, household power systems, field power systems, and other systems requiring higher power quality).



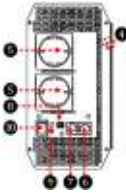

Features:

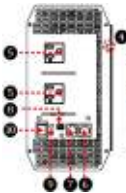
- Pure sine wave output
 - Input to output electrical isolation
 - Output power factor up to 1
 - Input Protection: Low-voltage, Over-voltage
 - Output Protection: Overload, Short circuit, Overheating
 - RS485 com. port to realize remote monitoring^①
 - External switch design, matched with EPEVER products, to expand inverter control function and reduce power consumption
 - Diversified AC output sockets
 - EN/IEC62109-1/2, EN61000-6-2/4, and FCC approved
- ① For inverters with 12V/24V input voltage, the RS485/RJ11 port has NO communication isolation design. This function (communication isolation design) is just for inverters with 48V input voltage.**

2 Appearance

	100/110/120VAC		220/230/240VAC	
IPT350	AC output port	T, N	AC output port	T, C, A, E, F, UK
	 <p>Figure 1</p>		<p>The appearance is the same as "Figure 1."</p>	
IPT500	AC output port	T, N	AC output port	T, C, A, E, F, UK
	 <p>Figure 2</p>		<p>The appearance is the same as "Figure 2."</p>	
IPT1000	AC output port	T, N, TN, GFCI	AC output port	T, C, TC, E, TE, F, TF, A, TA, UK, TUK

	 <p style="text-align: center;">Figure 3</p>		<p>The appearance is the same as "Figure 3."</p>	
IPT1500	<p>AC output port</p> 	<p>T, N, TN, GFCI</p>  <p style="text-align: center;">Figure 4</p>	<p>AC output port</p>	<p>T, C, TC, E, TE, F, TF, A, TA, UK, TUK</p> <p>The appearance is the same as "Figure 4."</p>
IPT2000	<p>AC output port</p> 	<p>T, N, TN, GFCI</p>  <p style="text-align: center;">Figure 5</p>	<p>AC output port</p>	<p>T, C, TC, E, TE, F, TF, A, TA, UK, TUK</p> <p>The appearance is the same as "Figure 5."</p>

IPT3000-11 IPT3000-12	AC output port	T, TN	 <p>Figure 6</p>	AC output port	T, TC, E, TE, F, TF, TA, TUK	 <p>Figure 7</p>
	AC output port	T, TN			AC output port	
IPT3000-21 IPT3000-22 IPT3000-41	AC output port	T, TN	 <p>Figure 8</p>	The appearance is the same as "Figure 8."		
	AC output port	T, TC, E, TE, F, TF, TA, TUK		AC output port	T, TC, E, TE, F, TF, TA, TUK	
IPT3000-42	--		 <p>Figure 9</p>	AC output port	T, TC, E, TE, F, TF, TA, TUK	
	AC output port	T, TN		AC output port	T, TC, TE, TF, TA, TUK	

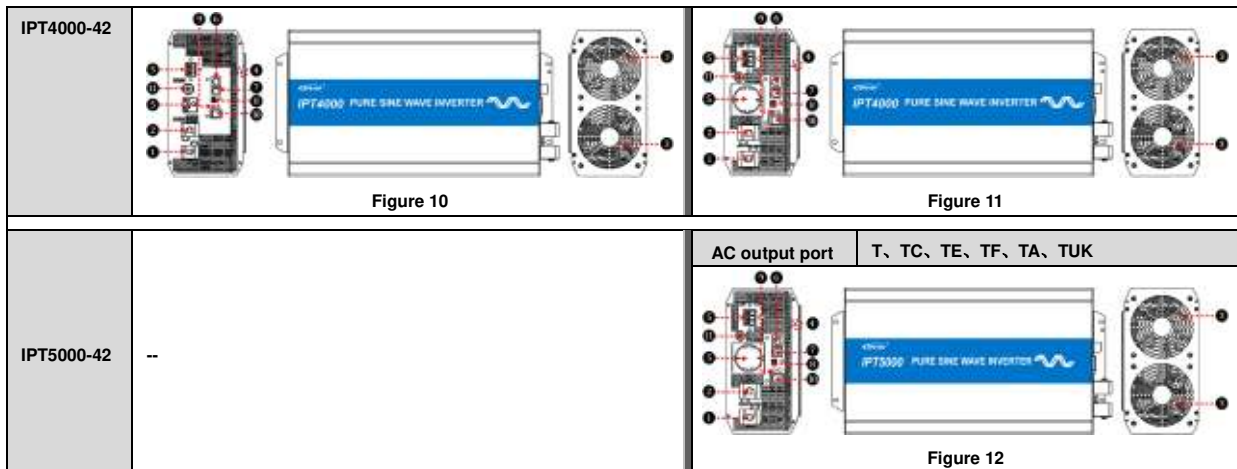

1	DC input terminal positive ^①	4	Grounding terminal	7	Remote switch port (RJ11, Reserved)	10	Inverter switch
2	DC input terminal negative ^①	5	AC output port ^①	8	External switch port (To connect an external relay)	11	Fast-acting fuse terminal ^④
3	Cooling fan	6	RS485 communication port ^②	9	Indicator ^③	--	--

① The DC input terminal and the AC output port varies with different products. Please refer to the real product.

② The RS485 communication port can be connected to the remote meter, Bluetooth module, WIFI module, PC, etc., for parameter setting and remote monitoring.

③ Indicators include the Power indicator and Fault indicator. The indicator and buzzer status under different working conditions are shown in the table below.

Power indicator	Fault indicator	Buzzer	Status
Green ON	Red OFF	No beeps	Output voltage normal
Green slowly flashing(1/4Hz)	Red OFF	Buzzer beeps.	Input under voltage
Green fast flashing (1Hz)	Red OFF	Buzzer beeps.	Input over voltage
Green OFF	Red ON solid	Buzzer beeps.	Inverter or the heat sink over temperature
Green OFF	Red fast flashing (1Hz)	Buzzer beeps.	Load short-circuit
Green ON	Red slowly flashing(1/4Hz)	Buzzer beeps.	Overload

- ④ The main purpose of the fast-acting fuse terminal ⑪ is to protect the AC socket. The load connected to the product, equipped with a fast-acting fuse terminal, cannot exceed the marked 10A or 20A.

Note: Not all the IPT products are equipped with the fast-acting fuse terminal; the actual products prevail.

➤ **Cooling fan**

Conditions to start the cooling fan	
The heat sink temperature is higher than 45°C or The internal inverter temperature is higher than 45°C or The output power is higher than 50% of the rated power	All IPT models
Conditions to stop the cooling fan	
The heat sink temperature is lower than 40°C and The internal inverter temperature is lower than 40°C and The output power is lower than 30% of the rated power	IPT500W and below products
The heat sink temperature is lower than 40°C and The internal inverter temperature is lower than 40°C and The output power is lower than 40% of the rated power	IPT1000W and above products

3 Naming rule

IPT 5000 - 4 2 (TC / RS)

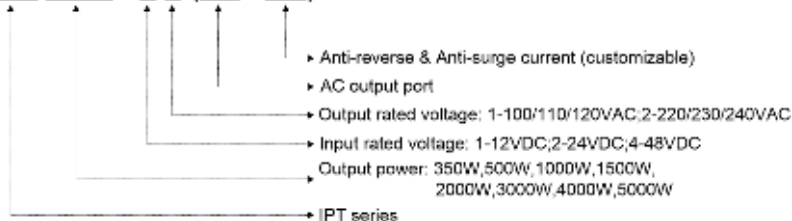





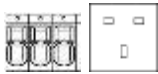

1. Instructions for the anti-reverse and anti-surge current protection

Product type	Suffix	Definition
Standard products	No	Without reverse polarity and anti-surge current protection
Customized products	R	With reverse polarity protection, without anti-surge current protection
	S	Without reverse polarity protection, with anti-surge current protection
	RS	With reverse polarity and anti-surge current protection

2. Explanations for the AC output port

Suffix	Instruction	Figure	Suffix	Instruction	Figure
T	Terminal		GFCI★	American socket (Ground Fault Circuit Interrupt★)	
C	Chinese dual-socket		TC	Terminal + Chinese	
E	European socket		TE	Terminal + European	
A	Australia socket		TA	Terminal + Australia	

UK	United Kingdom socket		TUK	Terminal + United Kingdom	
F	French socket		TF	Terminal + French	
N	American Socket (Applicable to 1500W and below products)		TN	Terminal + American (Applicable to 1500W and below products)	
	American socket (Applicable to 2000W and above products)			Terminal + American (Applicable to 2000W and above products)	

★ GFCI socket needs to be tested after power-on to ensure proper operation.

A. Preparation

Connect a circuit breaker and an AC load (it is recommended to use a night light to observe the status conveniently) to the GFCI socket. Turn on the inverter after confirming the wiring.

B. Testing

- 1) If the red LED is ON solid, it indicates that the GFCI socket is damaged; please replace a new one.
- 2) If the LED is green ON after it flashes in red three times, connect the circuit breaker, and the night light will be turned on. Then, press the "TEST" button to observe the testing status:
 - ① The "TEST" button always pops up, and the night light keeps ON solid. It indicates that the GFCI wiring is an error; please correct it.
 - ② The "TEST" button goes down, while the "RESET" button pops up. The LED and the night light are turned off, indicating the GFCI socket is normal (**Note: Press the "RESET" button again to recover the load output**).

 CAUTION	For detailed product model Vs. AC output port; please refer to the "IPT Model List."
---	---

4 Connection diagram

➤ **The DC input and AC sockets are located on different sides**

The DC input and AC sockets are located on different sides, such as IPT350, IPT500, IPT1000, IPT1500, IPT2000, and IPT3000-42. The following takes **IPT2000-2x** as an example to introduce the system connection.

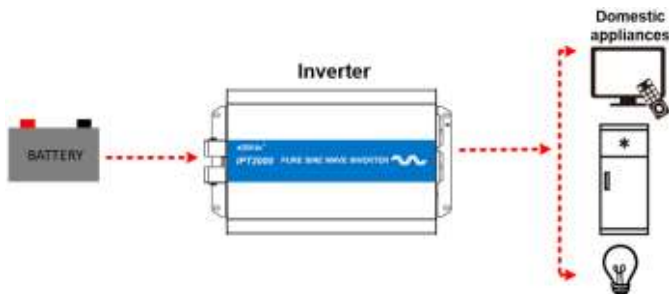

➤ **The DC input and AC sockets are located on the same side**

The DC input and AC sockets are located on the same side, such as IPT3000-1x/2x, IPT3000-41, IPT4000-4x, and IPT5000-42. The following takes **IPT3000-1x** as an example to introduce the system connection.

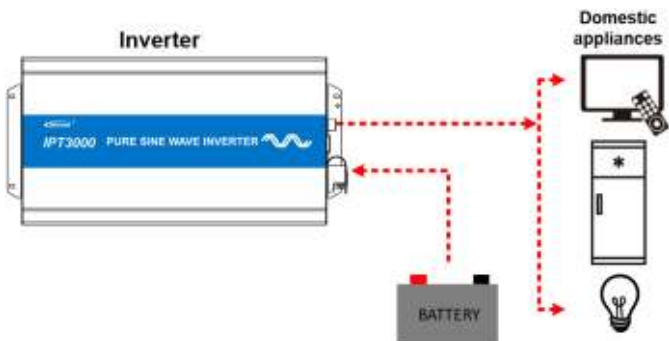

CAUTION

It is recommended to directly connect the inverter DC input terminal to the battery terminal. DO NOT connect it to the charge source terminal. Otherwise, the charging voltage spikes of the charge source may cause over-voltage protection of the inverter.

5 Installation

5.1 Attentions

- Read all the installation instructions carefully in the manual before installation.
- Be very careful when installing the batteries. When installing the open-type lead-acid battery, please wear eye protection and rinse with clean water for battery acid contact.
- Keep the battery away from any metal objects, which may cause a short circuit of the battery.
- Loose power connectors and corroded wires may result in high heat, melt wire insulation, burn surrounding materials, or cause a fire. Ensure tight connections and secure cables with cable clamps to prevent them from swaying in moving applications.
- The DC input voltage must strictly follow the parameter table. Too high or too low DC input voltage affects the normal operation and may damage the inverter. DC input 12V: Surge voltage < 20V. DC input 24V: Surge voltage < 40V. DC input 48V: Surge voltage < 80V.
- Select the system cables according to 3.5A/mm² or less current density.
- Avoid direct sunlight and rain infiltration when installing it outdoor.
- After turning off the power switch, do not open or touch the internal component immediately. Performing related operations after 10 minutes is recommended.
- Do not install the inverter in a harsh environment such as humid, salt spray, corrosion, greasy, flammable, explosive, or dust accumulation.
- The AC output is of high voltage, do not touch the wiring connection to avoid electric shock.
- To prevent injury, do not touch the fan while it is working.

5.2 Wire size and circuit breaker

The wiring and installation methods conform to the national and local electrical code requirements.

➤ Wire, terminals, and circuit breaker selection for battery

Model	Battery wire size	Ring terminal	Circuit breaker
IPT350-11	6mm ² /10AWG	RNB5.5-6	DC/2P-40A
IPT350-12	6mm ² /10AWG	RNB5.5-6	DC/2P-40A
IPT350-21	2.5mm ² /13AWG	RNB3.5-6	DC/2P-32A
IPT350-22	2.5mm ² /13AWG	RNB3.5-6	DC/2P-32A
IPT500-11	10mm ² /7AWG	RNB8-6S	DC/2P—63A
IPT500-12	10mm ² /7AWG	RNB8-6S	DC/2P—63A

IPT500-21	6mm ² /10AWG	RNB5.5-6	DC/2P-32A
IPT500-22	6mm ² /10AWG	RNB5.5-6	DC/2P-32A
IPT1000-11	25mm ² /3AWG	RNB38-6	DC/2P—125A
IPT1000-12	25mm ² /3AWG	RNB38-6	DC/2P—125A
IPT1000-21	16mm ² /5AWG	RNB14-6S	DC/2P—63A
IPT1000-22	16mm ² /5AWG	RNB14-6S	DC/2P—63A
IPT1000-41	6mm ² /10AWG	RNB5.5-6	DC/2P-40A
IPT1000-42	6mm ² /10AWG	RNB5.5-6	DC/2P-40A
IPT1500-11★	25mm ² /3AWG	RNB60-6	DC-100A(2P in parallel)
IPT1500-12★	25mm ² /3AWG	RNB60-6	DC-100A(2P in parallel)
IPT1500-21	16mm ² /5AWG	RNB14-6S	DC/2P—125A
IPT1500-22	16mm ² /5AWG	RNB14-6S	DC/2P—125A
IPT1500-41	10mm ² /7AWG	RNB14-6S	DC/2P—63A
IPT1500-42	10mm ² /7AWG	RNB14-6S	DC/2P—63A
IPT2000-11★	35mm ² /2AWG	RNB70-10	DC-125A(2P in parallel)
IPT2000-12★	35mm ² /2AWG	RNB70-10	DC-125A(2P in parallel)
IPT2000-21	35mm ² /2AWG	RNB38-6	DC/2P—125A
IPT2000-22	35mm ² /2AWG	RNB38-6	DC/2P—125A
IPT2000-41	16mm ² /5AWG	RNB14-6S	DC/2P—63A
IPT2000-42	16mm ² /5AWG	RNB14-6S	DC/2P—63A
IPT3000-11★	25mm ² /3AWG	RNB80-10	DC-125A(3P in parallel)
IPT3000-12★	25mm ² /3AWG	RNB80-10	DC-125A(3P in parallel)
IPT3000-21★	25mm ² /3AWG	RNB60-6	DC-100A(2P in parallel)
IPT3000-22★	25mm ² /3AWG	RNB60-6	DC-100A(2P in parallel)
IPT3000-41	25mm ² /3AWG	RNB22-6S	DC/2P—125A
IPT3000-42	25mm ² /3AWG	RNB22-6S	DC/2P—125A
IPT4000-41	35mm ² /2AWG	RNB38-6	DC/2P—125A
IPT4000-42	35mm ² /2AWG	RNB38-6	DC/2P—125A
IPT5000-42★	25mm ² /3AWG	RNB60-6	DC-100A(2P in parallel)

★ According to the recommended battery wire size, **2** battery wires, connected in parallel, are necessary for IPT1500-11, IPT1500-12, IPT2000-11, IPT2000-12, IPT3000-21, IPT3000-22, and IPT5000-42. For connection method, refer to the right figure.

4 battery wires, connected in parallel, are necessary for IPT3000-11 and IPT3000-12.



CAUTION

The above wire size and circuit breaker size are for reference only; please choose a suitable wire and circuit breaker according to the actual situation.

➤ Wire and circuit breaker selection for AC output

Model	Wire size	Circuit breaker
IPT350-11	1mm ² /18AWG	AC/2P—6A
IPT350-12	1mm ² /18AWG	AC/2P—6A
IPT350-21	1mm ² /18AWG	AC/2P—6A
IPT350-22	1mm ² /18AWG	AC/2P—6A
IPT500-11	1mm ² /18AWG	AC/2P—10A
IPT500-12	1mm ² /18AWG	AC/2P—6A
IPT500-21	1mm ² /18AWG	AC/2P—10A
IPT500-22	1mm ² /18AWG	AC/2P—6A
IPT1000-11	2.5mm ² /13AWG	AC/2P—16A
IPT1000-12	1.5mm ² /15AWG	AC/2P—10A
IPT1000-21	2.5mm ² /13AWG	AC/2P—16A
IPT1000-22	1.5mm ² /15AWG	AC/2P—10A
IPT1000-41	2.5mm ² /13AWG	AC/2P—16A
IPT1000-42	1.5mm ² /15AWG	AC/2P—10A
IPT1500-11	4mm ² /11AWG	AC/2P—25A
IPT1500-12	1.5mm ² /15AWG	AC/2P—10A
IPT1500-21	4mm ² /11AWG	AC/2P—25A
IPT1500-22	1.5mm ² /15AWG	AC/2P—10A
IPT1500-41	4mm ² /11AWG	AC/2P—25A
IPT1500-42	1.5mm ² /15AWG	AC/2P—10A
IPT2000-11	4mm ² /11AWG	AC/2P—32A
IPT2000-12	2.5mm ² /13AWG	AC/2P—16A
IPT2000-21	4mm ² /11AWG	AC/2P—32A
IPT2000-22	2.5mm ² /13AWG	AC/2P—16A
IPT2000-41	4mm ² /11AWG	AC/2P—32A
IPT2000-42	2.5mm ² /13AWG	AC/2P—16A
IPT3000-11	6mm ² /10AWG	AC/2P—50A
IPT3000-12	4mm ² /11AWG	AC/2P—25A
IPT3000-21	6mm ² /10AWG	AC/2P—50A
IPT3000-22	4mm ² /11AWG	AC/2P—25A
IPT3000-41	6mm ² /10AWG	AC/2P—50A
IPT3000-42	4mm ² /11AWG	AC/2P—25A
IPT4000-41	6mm ² /10AWG	AC/2P—63A
IPT4000-42	4mm ² /11AWG	AC/2P—32A
IPT5000-42	4mm ² /11AWG	AC/2P—40A



CAUTION

- The above wire size and circuit breaker size are for reference only; please choose a suitable wire and circuit breaker according to the actual situation.
- The wire size is only for reference. Suppose there is a long distance between the

inverter and the battery. In that case, larger wires shall be used to reduce the voltage drop and improve the system performance.

- The above wire size and circuit breaker size are for reference; please choose a suitable wire and circuit breaker according to the actual situation.

5.3 Mounting

Installation procedures:

Step1: Professional personnel reads this manual carefully.

Step 2: Determine the installation location and heat-dissipation space

The inverter shall be installed in a place with sufficient airflow through the dissipation pad of the inverter. And a minimum clearance of 150mm from the upper and lower edges of the inverter is recommended to ensure natural thermal convection. The following takes IPT3000-1x as an example.



CAUTION

It is not recommended to install the product in an enclosed cabinet, where the device cooling will be influenced. If mounted in an enclosure cabinet, ensure effective ventilation and not turn on all loads. Or else the device over temperature protection is caused.

Step3: Wiring



CAUTION

- Turn off the inverter switch before wiring.
- Please do not connect the circuit breaker or fast-acting fuse during the wiring and ensure that the poles' leads are connected correctly.
- The terminals and ports on the side vary from the product models.

Wiring sequence (The following wiring sequence is illustrated in the appearance "IPT3000-11", wiring positions of other inverters. Please refer to chapter [2 Appearance](#) for reference.)

1. Ground connection

The wire size for the ground connection must be thicker or equal to that for the AC output. Refer to chapter [5.2 Wire size and circuit breaker](#) for detailed wire size.

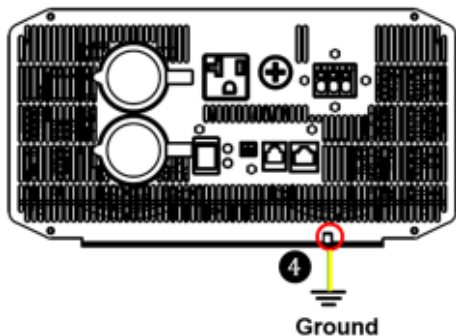

2. Battery connection



A fast-acting fuse must be installed on the battery side, conformed to the following requirements.

1. Fast-acting fuse voltage is 1.5 to 2 times the inverter's rated voltage.
2. Fast-acting fuse current is 2 to 2.5 times the inverter's rated current.
3. Distance between the fast-acting fuse and the battery cannot be farther than 150mm.

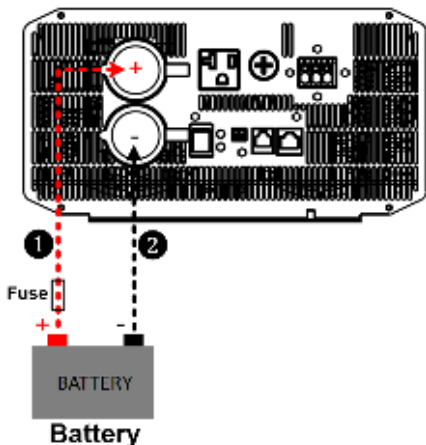

3. AC loads connection



- The AC loads shall be determined by the continuous output power of the inverter. The surge power of the AC load must be lower than the instantaneous surge power of the inverter, or the inverter will be damaged.
- The N pole of the AC output port cannot be grounded. If grounding the N pole is

necessary, please purchase the IPower-Plus-B series.

- 1) **Definition of the AC output port** (it varies with different product models; please refer to the actual product.)

The AC output ports of IPT3000-11 include terminal and North American socket. The following takes the AC terminal as an example.



- ✦ It is recommended to use multi-stranded wire with a diameter of not more than 6mm².
- ✦ Add solder to the connection point when selecting the multi-stranded wire and directly insert it into the corresponding port.

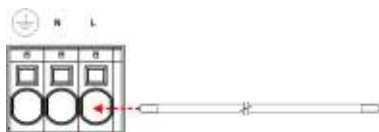

- ✦ Turn off the inverter before removing the wiring. Then, insert a sharp tool into the small hole (on the top of the port) and pull out the wiring forcefully.

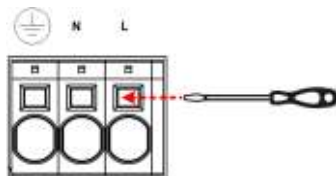

- 2) **Connect the AC load**

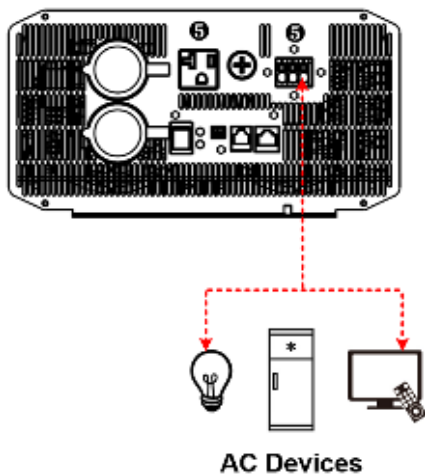

4. Optional accessories connection

1) RS485 communication port



RJ45 Pin Definition:

Pin	Definition	Instruction	Pin	Definition	Instruction
1	+5VDC	5V/200mA	5	RS485-A	RS485-A
2	+5VDC		6	RS485-A	
3	RS485-B	RS485-B	7	GND	Power GND
4	RS485-B		8	GND	

2) Connect optional accessories

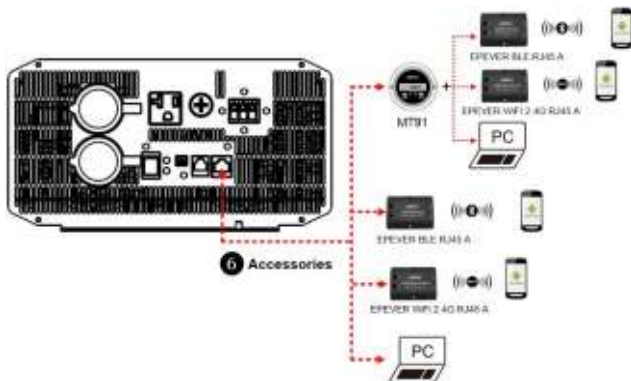

5. (Reserved) Remote switch connection

1) RJ11 port



RJ11 Pin Definition:

Pin	Definition	Instruction	Pin	Definition	Instruction
1	Switch+	Switch+	4	LED_R	Red light drive
2	Switch-	Switch-	5	GND	Power GND
3	+5VDC	5V/200mA	6	LED_G	Green light drive

2) Connect remote switch

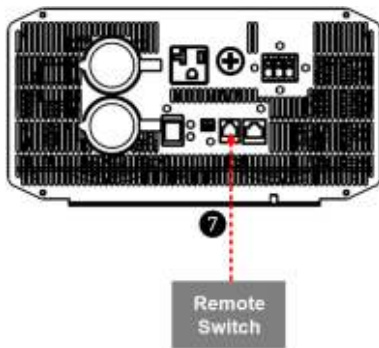

Step 4: Power on the inverter

- (1) Connect the breaker at the inverter input terminal or the fast-acting fuse at the battery terminal.
- (2) Turn on the inverter switch, and the green indicator will be lighted on, which states a normal AC output.
- (3) Connect the breaker at the AC load terminal, turn on the AC loads, and check the system working status.



CAUTION

When supplying power for different loads, it is recommended to first turn on the load with a large impulse current. And then turn on the load with a smaller impulse current after the load output is stable.

- (4) If the FAULT indicator flashes red and the buzzer alarms after powering the inverter, please immediately turn off the load and the inverter. Clear the faults according to chapter [8 Troubleshooting](#). After clearing the faults, please operate the inverter again by following the above steps.

6 Parameters setting

IPT parameters such as power saving mode, baud rate, output voltage class, and output frequency class can be set by the remote meter, phone APP, or PC software. The following chapters take parameters setting on the remote meter as an example (for connection of the remote meter, please refer to chapter [5.3 Mounting](#)).

6.1 Power Saving Mode



Users can enable the power saving mode and set the PSI/PSO value by the remote meter (The minimum power step is 1VA).

When the actual load power is lower than the PSI (the power to enter the power saving mode), the system will automatically switch to the power saving mode. And then, the device output is turned on for 1s and turned off for 5s.

When the actual load power exceeds the PSO (the power to exit the power saving mode), the inverter will automatically exit the power saving mode and resume work.

1) Enable power saving mode (PSE)

Step1: In the real-time interface of the remote meter, press and hold the  button to enter the parameters setting interface.

Step2: Click the  or  button to select the PSE parameter.

Step3: Press and hold the  button until the PSE parameter (OFF default) flashes.

Step4: Click the  or  button to set the PSE state.



- Select ON to enable the power saving mode.
- Select OFF to disable the power saving mode.





Step5: Press and hold the  button to confirm.

2) Set the power to exit the power saving mode (PSO)

Step1: In the parameters setting interface, click the  or  button to select the PSO parameter.

Step2: Press and hold the  button until the PSO value flashes.

Step3: Click the  or  button to set the PSO parameter.



- Click the  button to decrease the PSO value by 1.
- Click the  button to increase the PSO value by 1.
- Press and hold the  button to increase the PSO value by 10. After ten adding, the PSO value will increase by 100 each time. When the  button is released, press and hold it again to repeat the above operation. **Note: The setting parameter cannot exceed the user define, or else; it will return to the initial value to start the loop.**





Step4: Press and hold the  button to confirm.

3) Set the power to enter the power saving mode (PSI)

Step1: In the parameters setting interface, click the  or  button to select the PSI parameter.

Step2: Press and hold the  button until the PSI value flashes.

Step3: Click the  or  button to set the PSI parameter.

- Click the  button to decrease the PSI value by 1.
- Click the  button to increase the PSI value by 1.
- Press and hold the  button to increase the PSI value by 10. After ten adding, the PSI value will increase by 100 each time. When the  button is released, press and hold it again to repeat the above operation. **Note: The setting parameter cannot exceed the user define, or else; it will return to the initial value to start the loop.**



Step4: Press and hold the  button to confirm.

6.2 Other parameters



Users can set the baud rate, output voltage class and output frequency class, etc. by the remote meter.

Operation:



Step1: In the real-time interface, press  for 2s to enter the parameter setting interface.

Step2: Click  or  to select the parameter to be configured.











Step3: Press  for 2s to enter the configuration interface of the specified parameter.

Step4: Click  or  to configure the parameter value.

Step5: Press  for 2s to confirm the configuration.

Step6: Click  +  to exit the current interface.

Parameters user define:

Display	Parameters	Default	User define
 VPT	Output voltage class ^①	220VAC	220VAC/230VAC/240VAC
		110VAC	100VAC/110VAC/120VAC
 FRE	Output frequency class ^①	220/230/240VAC: 50Hz	50Hz/60Hz
		100/110/120VAC: 60Hz	
 BLT	LCD backlight time	30s	30s/ 60s/100s(ON solid)
 PSE	Power Saving Enable	OFF	ON/OFF
 PSI	Power Saving In	20VA	20VA ~ (20%*rated power)
 PSO	Power Saving Out	40VA	(20VA + PSI) ~ (50%*rated power)
 BRS	Baud Rate Select ^②	115200	9600/115200
 LVD	Low voltage disconnect voltage ^③	12V: 10.8V	12V: 10.5V~14.2V; step size 0.1V
		24V: 21.6V	24V: 21V-30.2V; step size 0.1V
		48V: 43.2V	48V: 42V-62.4V; step size 0.1V
 LVR	Low voltage reconnect voltage ^③	12V: 12.5V	12V: 11.5V~15.2V; step size 0.1V
		24V: 25V	24V: 22V-31.2V; step size 0.1V
		48V: 50V	48V: 43V-63.4V; step size 0.1V
 OVR	Over voltage reconnect voltage ^③	12V: 14.5V	12V: 11.5V~15.2V; step size 0.1V
		24V: 29V	24V: 22V-31.2V; step size 0.1V
		48V: 58V	48V: 43V-63.4V; step size 0.1V
 OVD	Over voltage disconnect voltage ^③	12V: 16V	12V: 10.5V~14.2V; step size 0.1V
		24V: 32V	24V: 21V-30.2V; step size 0.1V
		48V: 64V	48V: 42V-62.4V; step size 0.1V

① After configuring the parameters marked with ①, the inverter will restart automatically. It will resume work according to the new parameter value.

② Due to the length limit of the LCD displayed data. When the baud rate is set to 115200, the

value displayed on the LCD is 1152.

- ③ For the parameters marked with ③, please set them by the input voltage rules in chapter [7](#) [Protections](#). Otherwise, the parameter settings will not succeed.

7 Protections

1) Input voltage protection

- **The following rules must be followed when modifying the battery's input voltage parameters:**
 - A. Over voltage limiting voltage (16.2/32.2/64.4V) \geq Over voltage disconnect voltage \geq Over voltage reconnect voltage +1V.
 - B. Over voltage reconnect voltage \geq Low voltage reconnect voltage.
 - C. Low voltage reconnect voltage \geq Low voltage disconnect voltage +1V.
 - D. Low voltage disconnect voltage \geq Low voltage limiting voltage (10.5/21/42V).
- **Detailed status is shown as the following when the input voltage protection occurs.**

Input voltage protection	Status
Over voltage protection	The output is switched OFF immediately. The green indicator fast flashes. Buzzer beeps.
Over voltage recovery protection	The green indicator is ON solid. The output voltage is normal.
Low voltage protection	The output is switched OFF immediately. The green indicator Slowly flashes. Buzzer beeps.
Low voltage recovery protection	The green indicator is ON solid. The output voltage is normal.

 CAUTION	<p>Although the inverter is supplied with the input over-voltage protection, the surge voltage cannot higher than 20V for the 12V system, not higher than 40V for the 24V system, and not higher than 80V for the 48V system. Otherwise, the inverter may be damaged.</p>
---	---

Overload protection

IPT350-11 IPT350-12 IPT350-21 IPT350-22	S=1.2P _o (S: Output power; P _o : Rated power)	The output is switched OFF after 1 minute. Buzzer beeps. Red indicator slowly flashes.
	IPT500-11 IPT500-12 IPT500-21 IPT500-22	S=1.5P _o (S: Output power; P _o : Rated power)
IPT1000-11 IPT1000-12		S=1.8P _o (S: Output power; P _o : Rated power)

IPT1000-21 IPT1000-22 IPT1000-41 IPT1000-42 IPT1500-11 IPT1500-12 IPT1500-21 IPT1500-22 IPT1500-41 IPT1500-42 IPT2000-11 ★ IPT2000-12 IPT2000-21 IPT2000-22 IPT2000-41 IPT2000-42 IPT3000-21 ★ IPT3000-22 ★ IPT3000-41 IPT3000-42	$S \geq 2P_e$ (Rated input voltage) (S: Output power; P_e : Rated power)	Buzzer beeps. Red indicator slowly flashes. The output is switched OFF after 5 seconds. Buzzer beeps. Red indicator slowly flashes.
--	---	---



CAUTION

When the overload protection happens, the AC output will be recovered automatically three times (recover after 5s, 10s, and 15s separately). After three times recovery attempts fail, you need to restart the inverter to recover the AC output.

★When the overload protection happens on IPT2000-11, IPT3000-21, or IPT3000-22, the AC output is shut down and cannot be recovered automatically.

IPT3000-11	$S = 1.5P_e$ (S: Output power; P_e : Rated power)	The output is switched OFF after 10 seconds. Buzzer beeps. Red indicator slowly flashes.
	$S \geq 1.6P_e$ (S: Output power; P_e : Rated power)	The output is switched OFF after 5 seconds. Buzzer beeps. Red indicator slowly flashes.
IPT3000-12 IPT4000-41 IPT4000-42	$S = 1.5P_e$ (S: Output power; P_e : Rated power)	The output is switched OFF after 10 seconds. Buzzer beeps. Red indicator slowly flashes.
	$S \geq 1.7P_e$ (S: Output power; P_e : Rated power)	The output is switched OFF after 5 seconds. Buzzer beeps. Red indicator slowly flashes.

IPT5000-42	$S=1.2P_o$ (S: Output power; P_o : Rated power)	The output is switched OFF after 1 minute. Buzzer beeps. Red indicator slowly flashes.
	$S=1.4P_o$ (S: Output power; P_o : Rated power)	The output is switched OFF after 10 seconds. Buzzer beeps. Red indicator slowly flashes.
	$S>1.4P_o$ (Input rated voltage) (S: Output power; P_o : Rated power)	The output is switched OFF after 5 seconds. Buzzer beeps. Red indicator slowly flashes.

 CAUTION	When the overload protection happens, the AC output cannot recover automatically. The AC output will be shut down according to the multiple of the overload. You can recover the AC output after clearing the overload faults and restarting the inverter.
---	--

4) Output short circuit protection

Faults	Instruction
The output is switched OFF immediately. Buzzer beeps. Red indicator fast flashes.	Note: When the short circuit protection happens, the AC output will be recovered automatically three times (recover after 5s, 10s, and 15s separately). After three times recovery attempts fail, you need to restart the inverter to recover the AC output.

5) Inverter over temperature protection

Faults	Instruction
The red indicator is ON solid.	The inverter stops working after the temperature of the heat sink or the internal modules is higher than a set value.
Red indicator OFF	The inverter resumes work after the temperature of the heat sink or the internal modules is lower than a set value.

8 Troubleshooting



WARNING

A high voltage occurs inside the inverter. DO NOT try to repair or maintain the inverter by yourself, and it may cause an electric shock.

No.	Faults	Possible reasons	Troubleshooting
1	Green indicator Slowly flashes (1/4Hz) Red indicator turns OFF Buzzer beeps	The DC input voltage is too low.	Check whether the DC input voltage is lower than 10.8/21.6/43.2V by a multi-meter. The inverter resumes work after adjusting the input voltage.
2	Green indicator fast flashes (1Hz) Red indicator turns OFF Buzzer beeps	The DC input voltage is too high.	Check whether the DC input voltage is higher than 16/32/64V by a multi-meter. The inverter resumes work after adjusting the input voltage
3	Green indicator is ON solid Red indicator slowly flashes (1/4Hz) Buzzer beeps	Overload	Check whether the AC load's power is within the inverter's rated power; clear the overload faults, and restart the inverter.
4	Green indicator turns OFF Red indicator fast flashes (1Hz) Buzzer beeps	Load short-circuit	Check the load connection carefully. Clear the short circuit faults and restart the inverter.
5	Green indicator turns OFF Red indicator is ON solid. Buzzer beeps	Inverter over-temperature	Improve the ventilation situation and cool the surrounding temperature. It is recommended to restart the inverter after the temperature drops. If the fault cannot be cleared after performing the above operations, decline the rated power.

9 Maintenance

The following inspections and maintenance tasks are recommended at least two times per year for good performance.

- Make sure no block on airflow around the inverter. Clear up any dirt and fragments on the heat sink.
- Check all the naked wires to ensure insulation is not damaged by sun exposure, frictional wear, dryness, insects or rats, etc.
- Verify the indicator display is consistent with the actual operation.
- Confirm that terminals have no corrosion, insulation damage, high temperature, burnt/discolored sign, and tighten terminal screws to the suggested torque.
- Clear up dirt, nesting insects, and corrosion in time.
- Check and confirm that the lightning arrester is in good condition. Replace a new one in time to avoid damaging the inverter and other equipment.



WARNING

Risk of electric shock! Confirm all the power is turned off and all the capacitor's energy has been discharged before performing the above operations.

10 Specifications

100/110/120VAC output

Parameter	IPT350-11	IPT350-21	IPT500-11	IPT500-21
Continuous output power	350W@35°C@Rated input voltage		500W@35°C@Rated input voltage	
Surge power	700W@5S		1000W@5S	
Surge current when power on ^①	< 30A		< 50A	
Output voltage	100VAC/110VAC (±3%); 120VAC (-7%~+3%)			
Output frequency	50/60Hz ± 0.2%			
Output wave	Pure Sine Wave			
Output distortion THD	THD ≤ 4% (Resistive load)	THD ≤ 3% (Resistive load)	THD ≤ 4% (Resistive load)	
Load power factor	0.2 ~ 1 (Load power ≤ Continuous output power)			
Rated input voltage	12VDC	24VDC	12VDC	24VDC
Input voltage range	10.8 ~ 16.0VDC	21.6 ~ 32VDC	10.8 ~ 16.0VDC	21.6 ~ 32VDC
Rated output efficiency ^②	> 87.0%	> 90.0%	> 87.5%	> 90.0%
Max. output efficiency ^③	> 89.0% (70% loads)	> 90.5% (70% loads)	> 90.0% (40% loads)	> 91.0% (40% loads)
Idle current	< 0.15A	< 0.10A	< 0.15A	< 0.10A
No-load current	< 0.8A	< 0.4A	< 0.8A	< 0.5A
RS485 com. port	5VDC/200mA			
Mechanical parameters				
Input terminal	M6		M6	
Dimension (L x W x H)	229 × 160 × 73mm		286 × 160 × 73mm	
Mounting size (L x W)	205 × 75mm		262 × 75mm	
Mounting hole size	Φ5mm		Φ5mm	

Net Weight	1.5kg	2.3kg
------------	-------	-------

① The "Surge current when power on" parameter is for the customized products with an anti-surge function (whose product model has "S"). For other products, the actual surge current prevails.

② It means the rated output efficiency when the load power equals the "continuous output power" under the rated DC input voltage.

③ It means the max. output efficiency when the inverter is connected with different loads under the rated DC input voltage.

Parameter	IPT1000-11	IPT1000-21	IPT1000-41
Continuous output power	1000W@35°C@Rated input voltage		
Surge power	2000W@5S		
Surge current when power on ^①	< 100A		< 35A
Output voltage	100VAC/110VAC (±3%); 120VAC (-7%~+3%)		100VAC/110VAC/120VAC (±3%)
Output frequency	50/60Hz ± 0.2%		
Output wave	Pure Sine Wave		
Output distortion THD	THD ≤ 4% (Resistive load)	THD ≤ 3% (Resistive load)	THD ≤ 3% (Resistive load)
Load power factor	0.2 ~ 1 (Load power ≤ Continuous output power)		
Rated input voltage	12VDC	24VDC	48VDC
Input voltage range	10.8 ~ 16.0VDC	21.6 ~ 32.0VDC	43.2 ~ 64.0VDC
Rated output efficiency ^②	> 87.0%	> 90.0%	> 91.0%
Max. output efficiency ^③	> 92.0% (40% loads)	> 92.5% (30% loads)	> 92.5% (40% loads)
Idle current	< 0.2A	< 0.15A	< 0.1A
No-load current	< 0.8A	< 0.6A	< 0.5A
RS485 com. port	5VDC/200mA		
Mechanical parameters			
Input terminal	M6		M6
Dimension (L x W x H)	371 × 228 × 118mm		332×228×118mm

Mounting size (L x W)	345 × 145mm	306×145mm
Mounting hole size	Φ6mm	Φ6mm
Net Weight	4.8kg	4.5kg

① The "Surge current when power on" parameter is for the customized products with an anti-surge function (whose product model has "S"). For other products, the actual surge current prevails.

② It means the rated output efficiency when the load power equals the "continuous output power" under the rated DC input voltage.

③ It means the max. output efficiency when the inverter is connected with different loads under the rated DC input voltage.

Parameter	IPT1500-11	IPT1500-21	IPT1500-41
Continuous output power	1500W@35°C@Rated input voltage		
Surge power	3000W@5S		
Surge current when power on ^①	< 100A	< 100A	< 50A
Output voltage	100VAC/110VAC (±3%); 120VAC (-7%~+3%)		
Output frequency	50/60Hz ± 0.2%		
Output wave	Pure Sine Wave		
Output distortion THD	THD ≤ 4% (Resistive load)		
Load power factor	0.2 ~ 1 (Load power ≤ Continuous output power)		
Rated input voltage	12VDC	24VDC	48VDC
Input voltage range	10.8 ~ 16.0VDC	21.6 ~ 32.0VDC	43.2 ~ 64.0VDC
Rated output efficiency ^②	> 86.0%	> 88.0%	> 90.0%
Max. output efficiency ^③	> 93.0% (30% loads)	> 92.5% (30% loads)	> 92.0% (30% loads)
Idle current	< 0.2A	< 0.15A	< 0.1A
No-load current	< 1.0A	< 0.9A	< 0.5A
RS485 port	5VDC/200mA		
Mechanical parameters			

Input terminal	M6
Dimension (L x W x H)	387 x 228 x 118mm
Mounting size (L x W)	361 x 145mm
Mounting hole size	Φ6mm
Net Weight	5.6kg

① The "Surge current when power on" parameter is for the customized products with an anti-surge function (whose product model has "S"). For other products, the actual surge current prevails.

② It means the rated output efficiency when the load power equals the "continuous output power" under the rated DC input voltage.

③ It means the max. output efficiency when the inverter is connected with different loads under the rated DC input voltage.

Parameter	IPT2000-11	IPT2000-21	IPT2000-41
Continuous output power	2000W@35°C@Rated input voltage		
Surge power	4000W@5S		
Surge current when power on ^①	< 100A	< 100A	< 50A
Output voltage	100VAC/110VAC (±3%); 120VAC (-7%~+3%)		
Output frequency	50/60Hz ± 0.2%		
Output wave	Pure Sine Wave		
Output distortion THD	THD ≤ 5% (Resistive load)	THD ≤ 4% (Resistive load)	THD ≤ 4% (Resistive load)
Load power factor	0.2 ~ 1 (Load power ≤ Continuous output power)		
Rated input voltage	12VDC	24VDC	48VDC
Input voltage range	10.8 ~ 16.0VDC	21.6 ~ 32.0VDC	43.2 ~ 64.0VDC
Rated output efficiency ^②	> 85.0%	> 88.0%	> 88.0%
Max. output efficiency ^③	> 92.0% (30% loads)	> 92.0% (30% loads)	> 93.0% (30% loads)
Idle current	< 0.2A	< 0.15A	< 0.1A
No-load current	< 1.2A	< 0.9A	< 0.5A
RS485 com. port	5VDC/200mA		

Mechanical parameters		
Input terminal	M10	M6
Dimension (L x W x H)	420 x 228 x 118mm	421 x 228 x 118mm
Mounting size (L x W)	395 x 145mm	395 x 145mm
Mounting hole size	Φ6mm	Φ6mm
Net Weight	7.5kg	6.0kg

- ① The "Surge current when power on" parameter is for the customized products with an anti-surge function (whose product model has "S"). For other products, the actual surge current prevails.
- ② It means the rated output efficiency when the load power equals the "continuous output power" under the rated DC input voltage.
- ③ It means the max. output efficiency when the inverter is connected with different loads under the rated DC input voltage.

Parameter	IPT3000-11	IPT3000-21	IPT3000-41	IPT4000-41
Continuous output power	3000W@35°C@Rated input voltage			4000W@35°C@Rated input voltage
Surge power	4800W@5S	6000W@5S	6000W@5S	8000W@5S
Surge current when power on ^①	< 100A	< 100A	< 65A	< 65A
Output voltage	100VAC/110VAC (±3%); 120VAC (-7%~+3%)			
Output frequency	50/60Hz ± 0.2%			
Output wave	Pure Sine Wave			
Output distortion THD	THD ≤ 4% (Resistive load)	THD ≤ 5% (Resistive load)	THD ≤ 4% (Resistive load)	THD ≤ 4% (Resistive load)
Load power factor	0.2 ~ 1 (Load power ≤ Continuous output power)			
Rated input voltage	12VDC	24VDC	48VDC	48VDC
Input voltage range	10.8 ~ 16.0VDC	21.6 ~ 32.0VDC	43.2 ~ 64.0VDC	43.2 ~ 64.0VDC
Rated output efficiency ^②	> 85.0%	> 87.0%	> 89.5%	> 88.0%
Max. output efficiency ^③	> 93.0% (30% loads)	> 91.5% (30% loads)	> 93.5% (30% loads)	> 93.0%(30% loads)

Idle current	< 0.2A	< 0.15A	< 0.1A	< 0.1A
No-load current	< 1.6A	< 1A	< 0.4A	< 0.6A
RS485 com. port	5VDC/200mA			
Mechanical parameters				
Input terminal	M10	M6	M6	M6
Dimension (L x W x H)	550 x 270 x 143mm	521 x 270 x 143mm	516 x 228 x 118mm	521 x 270 x 143mm
Mounting size (L x W)	525 x 145mm	495 x 145mm	490 x 145mm	495 x 145mm
Mounting hole size	Φ6mm	Φ6mm	Φ6mm	Φ6mm
Net Weight	11.5kg	8.8kg	7.0kg	10.5kg

- ① The "Surge current when power on" parameter is for the customized products with an anti-surge function (whose product model has "S"). For other products, the actual surge current prevails.
- ② It means the rated output efficiency when the load power equals the "continuous output power" under the rated DC input voltage.
- ③ It means the max. output efficiency when the inverter is connected with different loads under the rated DC input voltage.

220/230/240VAC output

Parameter	IPT350-12	IPT350-22	IPT500-12	IPT500-22
Continuous output power	350W@35°C@ Rated input voltage		500W@35°C@Rated input voltage	
Surge power	700W@5S		1000W@5S	
Surge current when power on ^①	< 30A		< 50A	
Output voltage	220VAC (±3%); 230VAC (-6%~+3%); 240VAC (-9%~+3%)			
Output frequency	50/60Hz ± 0.2%			
Output wave	Pure Sine Wave			
Output distortion THD	THD ≤ 3% (Resistive load)			
Load power factor	0.2 ~ 1 (Load power ≤ Continuous output power)			
Rated input voltage	12VDC	24VDC	12VDC	24VDC
Input voltage range	10.8 ~ 16.0VDC	21.6 ~ 32VDC	10.8 ~ 16.0VDC	21.6 ~ 32VDC

Rated output efficiency ^②	> 89.0%	> 90.0%	> 89.5%	> 91.5%
Max. output efficiency ^③	> 90.0% (70% loads)	> 91.5% (70% loads)	> 91.0% (40% loads)	> 92.0% (40% loads)
Idle current	< 0.15A	< 0.10A	< 0.15A	< 0.10A
No-load current	< 0.9A	< 0.4A	< 0.9A	< 0.6A
RS485 com. port	5VDC/200mA			
Mechanical parameters				
Input terminal	M6		M6	
Dimension (L x W x H)	229 x 160 x 73mm		286 x 160 x 73mm	
Mounting size (L x W)	205 x 75mm		262 x 75mm	
Mounting hole size	Φ5mm		Φ5mm	
Net Weight	1.5kg		2.3kg	

- ① The "Surge current when power on" parameter is for the customized products with an anti-surge function (whose product model has "S"). For other products, the actual surge current prevails.
- ② It means the rated output efficiency when the load power equals the "continuous output power" under the rated DC input voltage.
- ③ It means the max. output efficiency when the inverter is connected with different loads under the rated DC input voltage.

Parameter	IPT1000-12	IPT1000-22	IPT1000-42
Continuous output power	1000W@35°C@Rated input voltage		
Surge power	2000W@5S		
Surge current when power on ^①	< 100A		< 35A
Output voltage	220VAC (±3%); 230VAC (-6%~+3%); 240VAC (-9%~+3%)		220VAC/230VAC/240VAC(±3%)
Output frequency	50/60Hz ± 0.2%		
Output wave	Pure Sine Wave		
Output distortion THD	THD ≤ 3% (Resistive load)		
Load power factor	0.2 ~ 1 (Load power ≤ Continuous output power)		
Rated input voltage	12VDC	24VDC	48VDC

Input voltage range	10.8 ~ 16.0VDC	21.6 ~ 32.0VDC	43.2 ~ 64.0VDC
Rated output efficiency ^②	> 89.0%	> 90.0%	> 92.0%
Max. output efficiency ^③	> 93.0% (40% loads)	> 93.0% (30% loads)	> 93.0% (40% loads)
Idle current	< 0.2A	< 0.15A	< 0.1A
No-load current	< 1.1A	< 0.9A	< 0.4A
RS485 com. port	5VDC/200mA		
Mechanical parameters			
Input terminal	M6		M6
Dimension (L x W x H)	371 x 228 x 118mm		332x228x118mm
Mounting size (L x W)	345 x 145mm		306x145mm
Mounting hole size	Φ6mm		Φ6mm
Net Weight	4.8kg		4.5Kg

① The "Surge current when power on" parameter is for the customized products with an anti-surge function (whose product model has "S"). For other products, the actual surge current prevails.

② It means the rated output efficiency when the load power equals the "continuous output power" under the rated DC input voltage.

③ It means the max. output efficiency when the inverter is connected with different loads under the rated DC input voltage.

Parameter	IPT1500-12	IPT1500-22	IPT1500-42
Continuous output power	1500W@35°C@Rated input voltage		
Surge power	3000W@5S		
Surge current when power on ^①	< 100A	< 100A	< 50A
Output voltage	220VAC (±3%); 230VAC (-6%~+3%); 240VAC (-9%~+3%)		
Output frequency	50/60Hz ± 0.2%		
Output wave	Pure Sine Wave		
Output distortion THD	THD ≤ 3% (Resistive load)		

Load power factor	0.2 ~ 1 (Load power ≤ Continuous output power)		
Rated input voltage	12VDC	24VDC	48VDC
Input voltage range	10.8 ~ 16.0VDC	21.6 ~ 32.0VDC	43.2 ~ 64.0VDC
Rated output efficiency ^②	> 89.0%	> 90.0%	> 92.5%
Max. output efficiency ^③	> 93.0% (30% loads)	> 93.5% (30% loads)	> 94.0% (30% loads)
Idle current	< 0.2A	< 0.15A	< 0.1A
No-load current	< 1.2A	< 0.9A	< 0.5A
RS485 com. port	5VDC/200mA		
Mechanical parameters			
Input terminal	M6	M6	M6
Dimension (L x W x H)	387 x 228 x 118mm	387 x 228 x 118mm	387 x 228 x 118mm
Mounting size (L x W)	361 x 145mm	361 x 145mm	361 x 145mm
Mounting hole size	Φ6mm	Φ6mm	Φ6mm
Net Weight	6.0kg	5.5kg	5.2kg

- ① The "Surge current when power on" parameter is for the customized products with an anti-surge function (whose product model has "S"). For other products, the actual surge current prevails.
- ② It means the rated output efficiency when the load power equals the "continuous output power" under the rated DC input voltage.
- ③ It means the max. output efficiency when the inverter is connected with different loads under the rated DC input voltage.

Parameter	IPT2000-12	IPT2000-22	IPT2000-42
Continuous output power	2000W@35°C@Rated input voltage		
Surge power	4000W@5S		
Surge current when power on ^①	< 100A	< 100A	< 50A
Output voltage	220VAC (±3%); 230VAC (-6%~+3%); 240VAC (-9%~+3%)		
Output frequency	50/60Hz ± 0.2%		

Output wave	Pure Sine Wave		
Output distortion THD	THD ≤ 3% (Resistive load)		
Load power factor	0.2 ~ 1 (Load power ≤ Continuous output power)		
Rated input voltage	12VDC	24VDC	48VDC
Input voltage range	10.8 ~ 16.0VDC	21.6 ~ 32.0VDC	43.2 ~ 64.0VDC
Rated output efficiency ^②	> 88.0%	> 90.0%	> 92.5%
Max. output efficiency ^③	> 94.0% (30% loads)	> 93.0% (30% loads)	> 94.5% (30% loads)
Idle current	< 0.2A	< 0.15A	< 0.1A
No-load current	< 1.2A	< 1.0A	< 0.5A
RS485 com. port	5VDC/200mA		
Mechanical parameters			
Input terminal	M10	M6	
Dimension (L x W x H)	420 x 228 x 118mm	421 x 228 x 118mm	
Mounting size (L x W)	395 x 145mm	395 x 145mm	
Mounting hole size	Φ6mm	Φ6mm	
Net Weight	7.0kg	5.8kg	

① The "Surge current when power on" parameter is for the customized products with an anti-surge function (whose product model has "S"). For other products, the actual surge current prevails.

② It means the rated output efficiency when the load power equals the "continuous output power" under the rated DC input voltage.

③ It means the max. output efficiency when the inverter is connected with different loads under the rated DC input voltage.

Parameter	IPT3000-12	IPT3000-22	IPT3000-42	IPT4000-42	IPT5000-42
Continuous output power	3000W@35°C@Rated input voltage			4000W@35°C@Rated input voltage	5000W@35°C@Rated input voltage
Surge power	6000W@5S			8000W@5S	
Surge current when power on ^①	< 100A	< 100A	< 65A	< 65A	

Output voltage	220VAC ($\pm 3\%$); 230VAC ($-6\% \sim +3\%$); 240VAC ($-9\% \sim +3\%$)				
Output frequency	50/60Hz $\pm 0.2\%$				
Output wave	Pure Sine Wave				
Output distortion THD	THD $\leq 3\%$ (Resistive load)				
Load power factor	0.2 ~ 1 (Load power \leq Continuous output power)				
Rated input voltage	12VDC	24VDC	48VDC	48VDC	
Input voltage range	10.8 ~ 16.0VDC	21.6 ~ 32.0VDC	43.2 ~ 64.0VDC	43.2 ~ 64.0VDC	
Rated output efficiency ^②	> 87.0%	> 90.0%	> 92.5%	> 91.0%	
Max. output efficiency ^③	> 94.0% (30% loads)	> 94.0% (30% loads)	> 94.5% (30% loads)	> 94.0% (30% loads)	
Idle current	< 0.2A	< 0.15A	< 0.1A	< 0.1A	< 0.1A
No-load current	< 1.6A	< 1.0A	< 0.5A	< 0.6A	< 0.8A
RS485 com. port	5VDC/200mA				
Mechanical parameters					
Input terminal	M10	M6	M6	M6	M6
Dimension (L x W x H)	557 x 228 x 118mm	521 x 270 x 143mm	491 x 228 x 118mm	516 x 228 x 118mm	531 x 228 x 118mm
Mounting size (L x W)	532 x 145mm	495 x 145mm	465 x 145mm	490 x 145mm	505 x 145mm
Mounting hole size	$\Phi 6$ mm	$\Phi 6$ mm	$\Phi 6$ mm	$\Phi 6$ mm	$\Phi 6$ mm
Net Weight	9.5kg	8.5kg	6.8kg	7.8kg	8.5kg

- ① The "Surge current when power on" parameter is for the customized products with an anti-surge function (whose product model has "S"). For other products, the actual surge current prevails.
- ② It means the rated output efficiency when the load power equals the "continuous output power" under the rated DC input voltage.
- ③ It means the max. output efficiency when the inverter is connected with different loads under the rated DC input voltage.

Environment parameters		Certification	
Environment temperature	-20°C ~ +60°C (Refer to the Derating Curve)	Safety	EN/IEC62109-1, UL458 (Products with 12/24V input voltage support), CSA C22.2#107.1

Storage temperature	-35 °C ~ +70 °C	EMC(Electromagnetic compatibility)	EN61000-6-2/EN61000-6-4, FCC 47 CFR Part 15, Subpart A
Relative humidity	≤ 95% (N.C.)	RoHS	IEC62321-3-1
Enclosure	IP20	—	
Altitude	< 5000m (If the altitude exceeds 1000 meters, the rated power will be reduced according to IEC62040.)		

Appendix 1 Disclaimers

The warranty does not apply to the following conditions:

- Damage is caused by improper use or an inappropriate environment (humid, salt spray, corrosion, greasy, flammable, explosive, dust accumulative, or other severe environments).
- The actual current/voltage/power exceeds the limit value of the inverter.
- Damage caused by working temperature exceeds the rated range.
- Arc, fire, explosion, and other accidents are caused by failure to follow the inverter stickers or manual instructions.
- Disassemble and repair the inverter without authorization.
- Damage caused by force majeure.
- Damage occurred during transportation or handling.
- Before using precise instruments, such as a medical instrument, end-users must read the manual carefully and ensure the inverter's output power/output voltage is suitable. We are not responsible for the instrument damage caused by improper use.

Any changes without prior notice! Version number: V2.1

HUIZHOU EPEVER TECHNOLOGY CO., LTD.

Tel: +86-752-3889706

E-mail: info@epever.com

Website: www.epever.com