

Product data

Product code	VA01-0252	STK-code	5200356	EAN-code	6410052003562
Product name	Cable lug PKK 6-6-45 Cu			ETIM class	EC001051
Wires	Cu 6 mm ²				

Technical data

	-	
	-	
	-	
	-	
	-	
	-	
	-	
Number of poles	1	pcs
Max. Cross section	6	mm ²
	-	
	-	
	-	
	-	
	-	
Weight	5	g
	-	
	-	
Color / Material	Tin plated copper	
Mounting / Connection	Crimping	

Description

Cable lugs are used for connecting copper cables. Installation of the cable lugs can be performed with the most basic crimping tools. Cable lugs are compatible with all kinds of stranded (also compressed and PEX-type) wires.

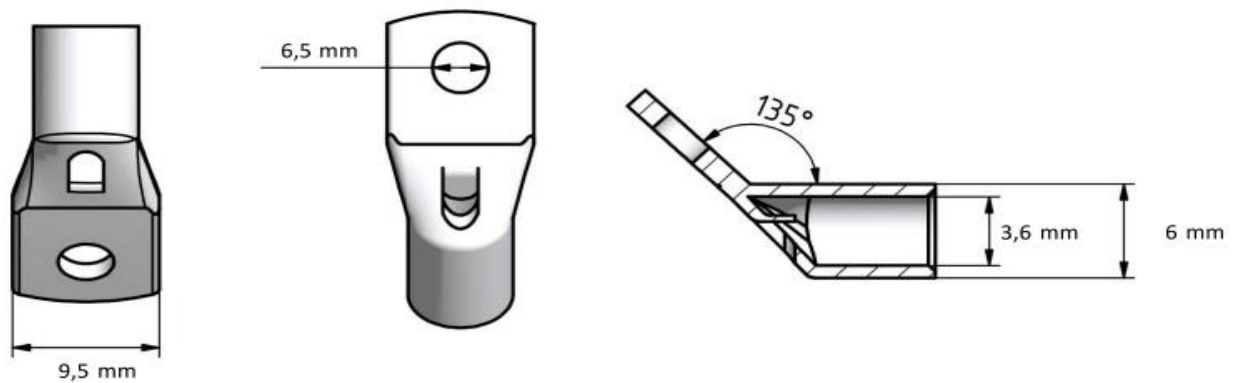
Drawing

Package

Package	Box	Pcs / Package	50	Weight [kg]	0,162
Length [mm]	32	Width [mm]	60	Height [mm]	110

Ouneva Oy

Teollisuustie 21
FI-82730 Tuupovaara
Finland

Tel. +358 400 179 750
info@ouneva.fi

www.ounevagroup.fi
www.ounevaproducts.fi